



Postage Meters

# mailstation2™

Digital Postage Meter

## Operator Guide

US English Edition  
SV61983 Revision M  
September, 2023

©2023 Pitney Bowes Inc.

All rights reserved. This book may not be reproduced in whole or in part in any fashion or stored in a retrieval system of any type or transmitted by any means, electronically or mechanically, without the express written permission of Pitney Bowes.

The use of this information by the recipient or others for purposes other than the training of customers on Pitney Bowes equipment may constitute an infringement of intellectual property rights of Pitney Bowes, and Pitney Bowes assumes no responsibility for any such use of the information.

We have made every reasonable effort to ensure the accuracy and usefulness of this manual. However, we cannot assume responsibility for errors or omissions or liability for the misuse or misapplication of our products.

Except as provided in writing, duly signed by an officer of Pitney Bowes, no license either express or implied, under any Pitney Bowes or third party's patent, copyright or other intellectual property rights is granted by providing this information.

The mailstation2 Operator Guide is designed to assist in the daily operations of the machine. Use this book as a reference, as it includes system operating procedures.

## Version History

Document Part Number	Release Date	Comments
<a href="#">SV61983 Rev J</a>	November 2014	Updates to Troubleshooting section and incorporation of PC Meter Connect information
<a href="#">SV61983 Rev K</a>	January 2015	Removal of references to analog connectivity.
<a href="#">SV61983 Rev L</a>	May 2018	Add SmartLink
<a href="#">SV61983 Rev M</a>	September 2023	Updated contact information

# Pitney Bowes Contact List

## Machine Identification

Product Name: mailstation2 Digital Postage Meter

Model Number: Refer to the label on the back or the bottom of the machine

If you need to contact customer support, refer to [What Information You Need to Provide Customer Support](#) before contacting support.

## Resources

For online technical support: go to <https://www.pitneybowes.com/us/support/products/mailstation-meter-support.html> and select a topic link from the appropriate section.

For Account Information: go to <https://www.pitneybowes.us/signin/> and sign in to your account.

## Shop

To order or check supplies online go to [pitneybowes.com/us/shopsupplies](https://www.pitneybowes.com/us/shopsupplies).

## USPS

[www.usps.com](https://www.usps.com)

# Table of Contents

Pitney Bowes Contact List .....	4
---------------------------------	---

## 1 - Safety

---

Introduction .....	2
Battery Handling (California Customers Only) .....	2
Ear Protection/Noise Exposure Guidelines .....	2
System Power .....	3
Operation .....	3
Maintenance .....	5

## 2 - Getting Started

---

Parts of the Machine .....	7
The Control Panel .....	8
Connections on the Back of the Machine .....	9

## 3 - What You Can Print on Mail Pieces

---

Printing Options .....	12
Check the Meter Stamp Imprint .....	12
What's in the Meter Stamp .....	13
Printing a Meter Stamp with an Advanced Date .....	14
Turning the Date On/Off for a Meter Stamp .....	14
Printing the Date and Time Only (no meter stamp) .....	15
Adding and Removing Advertisements at the Machine .....	15
Printing Ads Only (no meter stamp) .....	16
Adding and Removing Inscriptions .....	16

## 4 - Running Mail

---

Power up the Machine .....	19
Checking the Amount of Postage Available .....	19
Determine the Amount of Postage Needed .....	19
Do You Need Add-On USPS Services? .....	20
Applying Postage: Entering it Manually .....	20
Applying Postage Using Optional Internal Rating .....	21
Applying Postage Using Optional Scale and Internal Rating .....	22
Applying Postage Using Weight Hold Mode .....	23

## 5 - Using the Batch Mail Count Feature

---

Viewing the Batch Mail Count .....	26
Printing the Batch Count .....	27
Clearing the Batch Count .....	27

## 6 - Accounting

---

About accounts .....	30
Turning Accounts On and Off .....	31
Creating an account .....	31
Editing an account name and password .....	32
Selecting an account .....	33
Viewing Account Totals .....	33
Printing an Account Report .....	33
Clearing All or Some of the Accounts .....	34
Deleting an account .....	35

## 7 - Reports

---

About Reports .....	37
Printing a funds report .....	37
Printing your Last 5 Refills summary report .....	38
Printing an Account Report .....	39

System Software Version Report .....	40
View System Software Versions on Machine Only .....	41

## 8 - Connecting to the Data Centre

---

About System Settings .....	43
Setting the Contrast of the LCD Display .....	43
Setting System Time .....	43
Using the Preset Feature .....	44
Settings for the Optional Scale .....	46
Setting your Lock Code .....	47
Setting Sleep Mode Activation Time .....	47
Activating the Sleep Mode Manually .....	48
Setting the High Value Warning .....	48
Setting the Low Funds Warning .....	49

## 9 - Passwords and Meter Functions

---

About passwords and meter functions .....	51
---	----

## 10 - Connecting to the Data Center

---

How You Connect to the PB Data Center .....	54
Connect to the PB Data Center with SmartLink Using an Ethernet Cable to a LAN Port .....	56
Connect to PB Data Center with SmartLink Using a Wireless Connection .....	58
Connect to the PB Data Center with the Communication Device Using an Ethernet Cable to a LAN Port .....	60
Connect to the PB Data Center with the Communication Device Using a Wireless Connection .....	62
Connect to the PB Data Center with PC Meter Connect Application on your Computer .....	64

## 11 - Using PC Meter Connect

---

Starting PC Meter Connect™ .....	66
PC Meter Connect Application Main Window .....	69

Checking the Postage Amount using PC Meter Connect .....	71
Adding Postage using PC Meter Connect .....	71
Downloading new Postal Rates using PC Meter Connect .....	73
Performing Meter Inspections using PC Meter Connect .....	73
Printing a Meter Stamp with an Advanced Date Using PC Meter Connect .....	73
Adding or Removing Ads Using PC Meter Connect .....	74
Adding or Removing Postal Inscriptions using PC Meter Connect .....	74
Setting the System Time using PC Meter Connect .....	74
Turning the Preset On/Off using PC Meter Connect .....	75
Storing or Changing the Preset using PC Meter Connect .....	75
Viewing the Preset using PC Meter Connect .....	76
Resetting the Scale to Zero Using PC Meter Connect .....	76
Setting up the Weight Hold Method using PC Meter Connect .....	76
Setting the High Value Warning using PC Meter Connect .....	76
Setting the Low Funds Warning using PC Meter Connect .....	77
Viewing Account Totals using PC Meter Connect .....	77
Printing an Account Report using PC Meter Connect .....	77
Printing a Refill Summary Report Using PC Meter Connect .....	78
Viewing a System Software Version Report Using PC Meter Connect .....	78
Checking PC Meter Connect Version .....	78
Network Specifications and Requirements for PC Meter Connect .....	80

## 12 - Adding Postage

---

Adding Postage to Your Machine .....	85
--------------------------------------	----

## 13 - Meter Updates and Inspections

---

About Meter Updates and Downloads .....	88
About Postal Rate Changes .....	89
Procedures for Downloading New Postal Rates .....	90
Performing Meter Inspections .....	91

## 14 - Maintenance

---



Ink Cartridge Replacement Messages .....	94
Replacing the ink cartridge .....	94
Printing a Test Pattern .....	98
Cleaning printer nozzles .....	99
Cleaning or Replacing the Print Head .....	101
Replacing the Ink Tray .....	105

# 1 - Safety

Introduction.....	2
Battery Handling (California Customers Only).....	2
Ear Protection/Noise Exposure Guidelines.....	2
System Power.....	3
Operation.....	3
Maintenance.....	5

## Introduction

Familiarize yourself with proper procedures and methods before you install, operate or repair the system to avoid personal injury or damage to the equipment.

## Battery Handling (California Customers Only)

The battery used in this product contains perchlorate material. California requires perchlorate containing products to be accompanied by the following notice:

Perchlorate Material - Special handling may apply. For more information refer to the following website: [www.disc.ca.gov/hazardouswaste/perchlorate](http://www.disc.ca.gov/hazardouswaste/perchlorate).

## Ear Protection/Noise Exposure Guidelines

Ear protection is required if noise exposure exceeds OSHA standard. There are many factors to be taken into consideration in each individual work area when dealing with ear protection. Factors such as floor noise, length of exposure to noise, loss of hearing history in individual employees can all play a role in requirements. Analyze your specific work area environment to ensure safe practices.

### OSHA Standards

85dBA time weighted average over an 8-hour shift requires hearing protection be made available to employees and use is recommended. (European Union standard is 80dBA)

90dBA time weighted average over an 8-hour shift mandates hearing protection is used. (European Union standard is 85dBA)

---

NOTE: Local jurisdictions may have more stringent requirements. Refer to local regulations for standards and requirements in your area.

---

## System Power

- Use the power cord supplied with the machine chassis at the power entry and plug it into a properly grounded (earthed) and easily accessible wall outlet located near the machine. Failure to properly ground (earth) the machine can result in severe personal injury and/or fire.
- The power cord wall plug is the primary means of disconnecting the machine from AC power supply for Lock Out/Tag Out.
- *DO NOT* use an adapter plug on the line cord or wall outlet.
- *DO NOT* remove the ground pin from the line cord.
- The machine will be connected to a dedicated AC power line.
- *DO NOT* route the power cord over sharp edges or trap it between furniture.
- Ensure there is no strain on the power cord where it becomes jammed between the equipment, walls or furniture.
- Be certain the area in front of the wall receptacle into which the machine is plugged is free from obstruction.
- Ensure there is no strain on the power cord where it becomes jammed between the equipment, walls or furniture.
- For Input modules and Output modules - power is distributed from the chassis. Use the AC connectors supplied with the modules to connect to system power. Do not connect external devices to the inserter.

## Operation

- Only trained personnel are permitted to operate this equipment. Training must include instruction in operation under normal conditions and emergency situations.
- The machine will only be serviced by trained and authorized personnel. Disconnect power source before servicing.
- Personnel working on or near this equipment must be instructed about the location and operation of pertinent stopping devices.
- Never run the machine when any of the covers or guards are missing.
- This equipment is to be used only for the purpose for which it is constructed. Read this manual for the proper use of this equipment.

- Under no circumstances are the safety characteristics of this equipment to be altered. Routine inspections and preventative maintenance measures are to be conducted according to the appropriate schedules in order to ensure that all guards and safety features are active and functioning properly.
- Eliminate the risk of entanglement in certain areas of this machine by keeping loose clothing, jewelry, long hair and neckties away from all moving parts. Make sure that clothing and hair fit closely to your body and that all jewelry is removed.
- Before starting the machine, check that: - All persons are clear of the machine – No maintenance work is being performed on the machine - All guards are in place – The machine is free of scraps, jams and foreign objects.
- When opening guards, wait for all parts to stop moving before placing hands near paper path.
- When removing jammed material, avoid using too much force to prevent personal injury and damaging equipment.
- It is essential that personnel employ safe working practices and observe all related regulations and legal requirements for safety when operating this product.
- **WARNING & CAUTION statements are used in the text of this manual to identify specific hazards, which have potential to cause injury. Pitney Bowes declines all liability in the event of material damage or bodily injury resulting from negligence in the application of these precautions, from non-observation or lack of elementary supervision in respect to handling, operation, servicing or repair, even if not expressly stated in this instruction notice.**

## Maintenance

- If you train equipment operators, it's important to explain safety precautions to your students and encourage safety awareness.
- Only documented qualified service personnel should service this equipment per local national requirements.
- Only set-up maintenance, as described in this manual, is to be performed by operators. Any service that requires removal of protective covering is to be performed by qualified service personnel only.
- Use the right tool for the job. A set-up tool is supplied to accommodate running different size paper on the inserter.
- Use only Pitney Bowes approved printer ink and cleaners.
- To prevent overheating, do not cover the vent openings.
- Do not store flammable fluids inside this machine.
- Do not place any container with liquid on this machine, i.e. coffee cups, soda, etc.
- Do not use flammable cleaners in this machine.
- Do not use aerosol air canisters. It is recommended that a vacuum cleaner be used to remove dust and debris from the machine paper path. If you have to use shop air, be sure to turn the system off before you begin cleaning. Be sure shop air does not contain excessive oil or water.
- Do not spray liquid onto or into any part of the machine. Use a cloth to apply cleaning solution.

# 2 - Getting Started

Parts of the Machine.....	7
The Control Panel.....	8
Connections on the Back of the Machine.....	9

## Parts of the Machine





Item	Description
1	<b>Control Panel:</b> Allows you to enter and set up information on your mailing system.
2	<b>LCD Display:</b> Shows the current status of your machine and prompts you through all setup operations.
3	<b>LED:</b> Lights amber when your machine is low on ink (one blink indicates the machine is out of ink).
4	<b>Scale (optional):</b> Allows you to weigh a mail piece so you can calculate the correct postage, or the machine can calculate the correct postage if you purchased the optional internal rating feature.
5	<b>Mail Deck:</b> Feed the envelope, post card or tape sheet at the mail deck for printing.

## The Control Panel

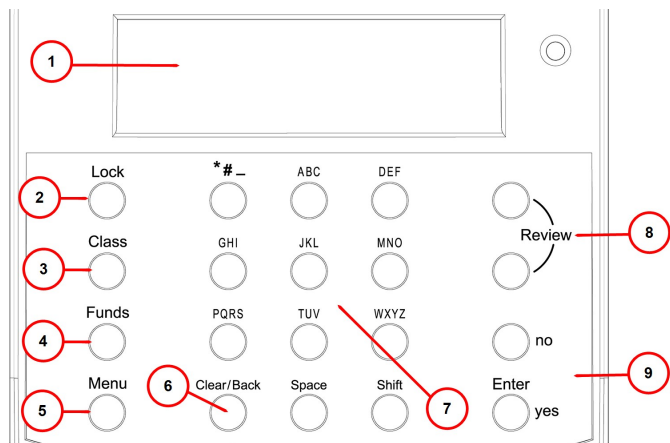

Item	Description
1	<b>LCD Display:</b> Shows the current status of your machine and prompts you through 5.8all setup operations in a two-line LCD.
2	<b>Lock Key:</b> Prevents unauthorized use of your machine if the lock feature is set up and the machine is in "sleep mode"; entering your four-digit password unlocks (awakens) the machine
3	<b>Class:</b> Allows you to select class and calculate postage based on the service selected if you have the optional internal rating system feature.
4	<b>Funds:</b> Allows you to check and add postage funds to your machine.
5	<b>Menu:</b> Allows you to access system settings so that you can customize your machine to accommodate the way you run your mail.
6	<b>Clear/Back:</b> Allows you to clear or cancel an entry or return to the previous screen/menu level.
7	<b>Alphanumeric Keypad:</b> Allows you to type in numbers and letters for account names, postage values, and other information.
8	<b>Review Keys:</b> Allows you to scroll through choices in the LCD display or review the current settings.
9	<b>Enter / Yes or No:</b> Allows you to confirm an operation or answer "Yes" or "No" to a prompt.

## Connections on the Back of the Machine

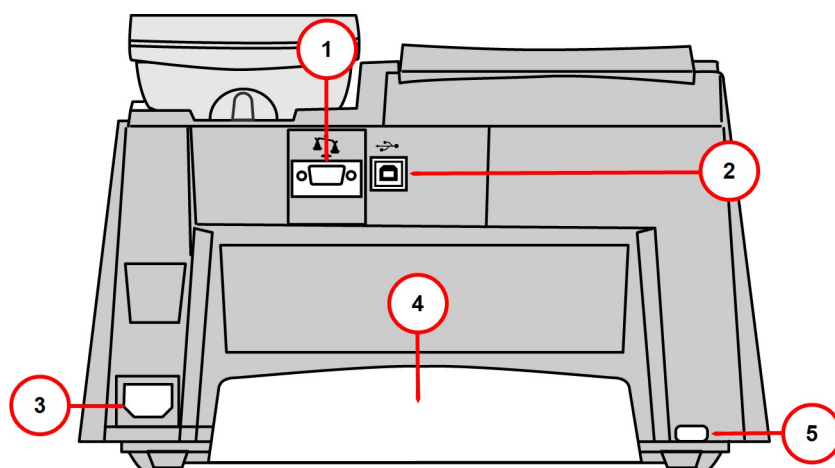

Item	Description
1	<b>Serial Port:</b> Allows you to connect the optional scale to weigh your mail piece.
2	<b>USB Port:</b> Allows you to attach a USB cable connected to either the SmartLink device, the Communication device or a Windows PC that has Internet access.
3	<b>Power Receptacle:</b> Connects to AC power cord (supplied)
4	<b>Ink Tray:</b> Holds excess ink that results from the printing process.
5	<b>Ink Tray Lever:</b> By sliding this lever you can remove the ink tray

# 3 - What You Can Print on Mail Pieces

Printing Options.....	12
Check the Meter Stamp Imprint.....	12
What's in the Meter Stamp.....	13
Printing a Meter Stamp with an Advanced Date.....	14
Turning the Date On/Off for a Meter Stamp.....	14
Printing the Date and Time Only (no meter stamp).....	15
Adding and Removing Advertisements at the Machine.....	15
Printing Ads Only (no meter stamp).....	16
Adding and Removing Inscriptions.....	16

## Printing Options

You can select to print the following components on your mail piece:

- A normal meter stamp, also referred to as the indicia includes:
  - Current date/time
  - Datamatrix barcode
  - ZIP Code of the machine
  - Meter serial number
  - Postage amount
- A *meter stamp with an advanced date*
- A *meter stamp with no date*
- A *meter stamp with \$0.00 postage*
- An *optional advertisement*
- An *optional postal inscription*
- An *optional postal endorsement*

For information on printing a normal meter stamp, refer to [Determining the Amount of Postage Needed](#).

For information on the locations of the meter stamp and optional components, refer to [What's in the Meter Stamp](#).

## Check the Meter Stamp Imprint

You can check the meter stamp imprint by printing a meter stamp with \$0.00 postage.

To print with \$0.00 postage, press **Zero** at the Home screen and press **Enter/yes**, and slide an envelope or a tape sheet into the machine.



## What's in the Meter Stamp

The location of the meter stamp items on a mail piece or tape strip are shown here.

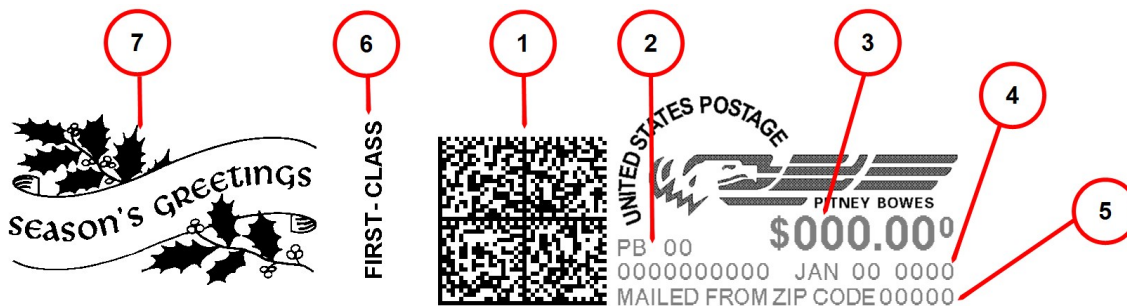

Item	Description
1	Datamatrix barcode - contains tracking information
2	Meter serial number
3	Postage amount
4	Date
5	ZIP Code of the machine
6	Optional postal inscription/class
7	Optional advertisement

## Printing a Meter Stamp with an Advanced Date

You may want to advance the date printed on the meter stamp if it is after normal business hours and you want to prepare outgoing mail for a future business day's mailing.

---

**NOTE:** The machine automatically advances the printed date on the meter stamp (as well as its internally held date) when the system time reaches 12:00 AM.

---

### Advanced Date Features

- You can advance the date up to 30 days from the current date.
- Changing the printed date does not change the machine's internally held date.
- You can always return the printed date to the current date.
- You cannot change the printed date to a date earlier than the machine's internally held date (in an effort to "backdate" the mail).
- Accounting data is posted on the actual date the mail piece is run (per the internal clock/calendar in the mailing system), *not by the date printed on the meter stamp*.

### How to Advance the Date Manually

1. Press **Menu**.
2. Use the **Review** keys to scroll to "Change date and time settings?" and press **Enter/yes**.
3. Use the **Review** keys to scroll to "Change printed date?" and press **Enter/yes**.
4. Use review keys to select a date. A message confirms your choice and the main screen displays.
5. To reset the date on your mail back to the current date, repeat steps 1-4 and select today's date.

If you have PC Meter Connect, refer to [How to Advance the Date Using PC Meter Connect](#).

## Turning the Date On/Off for a Meter Stamp

Most mailings print the date as part of the meter stamp but for certain classes of mail, you may want to turn off the date. Call your local post office or visit [www.usps.com](http://www.usps.com) for further information.

1. Press **Menu**.
2. Use the **Review** keys to scroll to "Change date and time settings?" and press **Enter/yes**.
  - *Turning Date Printing OFF* - use the **Review** keys to scroll to **Turn OFF date printing** and press **Enter/yes**. A message displays confirming your choice and the main screen displays dashes instead of a date.
  - *Turning Date Printing ON* - use the **Review** keys to scroll to **Turn ON date printing** and press **Enter/yes**. A message displays confirming your choice and the main screen displays the date.

## Printing the Date and Time Only (no meter stamp)

You may want to use this feature to time-stamp incoming mail or sensitive documents.

1. Press **Menu**.
2. Use the **Review** keys to scroll to "Change meter stamp type?" and press **Enter/yes**.
  - *Turning Date and Time Only Printing ON* - use the **Review** keys to scroll to **Print date and time only** and press **Enter/yes**. A message displays confirming your choice. The main screen displays only date and time.
  - *Turning Date and Time Only Printing OFF* - use the **Review** keys to scroll to **Print normal postage** and press **Enter/yes**. A message displays confirming your choice and the main screen displays the meter stamp with the date .

## Adding and Removing Advertisements at the Machine

1. Press **Menu**.
2. Use the **Review** keys to scroll to "Change Ad?" and press **Enter/yes**. The current ad (if any) is displayed.
  - *Adding an Ad* - use the **Review** keys to scroll to the ad you want and press **Enter/yes**. A message displays confirming your choice and the main screen displays the ad.
  - *Removing an Ad* - use the **Review** keys to scroll to **None** and press **Enter/yes**. A message displays confirming your choice and the main screen displays.

If you have PC Meter Connect, refer to [Adding and Removing Ads Using PC Meter Connect](#).



## Purchasing other Envelope Ads for your Machine

Your machine comes pre-loaded with six envelope ads. If you want another envelope ad, contact Pitney Bowes, see [Pitney Bowes Contact List](#). Ready-made ads can be purchased and downloaded directly into your machine. You can also work with Pitney Bowes to create custom ads.

## Printing Ads Only (no meter stamp)

1. Press **Menu**.
2. Use the **Review** keys to scroll to "Change meter stamp type?" and press **Enter/yes**.
  - *Turning ON Ad Only Printing* - use the **Review** keys to scroll to **Print ad only** and press **Enter/yes**. If you have already selected an ad for your normal meter stamp, that is the one used; otherwise, you are prompted to choose an ad. When completed the main screen displays with the ad only (sample here).
  - *Turning OFF Ad Only Printing* - use the **Review** keys to scroll to **Print normal postage** and press **Enter/yes**. The normal main screen displays.

## Adding and Removing Inscriptions

---

### **IMPORTANT:**

The postal inscription that prints on the meter stamp is a separate setting from the postal class you choose when you rate your mail piece. You rate the mail piece as part of the procedure(s) for running mail. The inscription and the class should match for your mail piece. However, if you change one of these on your mailing machine, it does NOT automatically change the other. If you change the inscription be sure it matches the class you select when processing mail. Refer to [Running Mail](#) in this guide.

---

1. Press **Menu**.
2. Use the **Review** keys to scroll to "Change inscription?" and press **Enter/yes**.
  - *Adding a Postal Inscription* - use the **Review** keys to scroll to the inscription you want and press **Enter/yes**. A message displays confirming your choice and the main screen displays the inscription.
  - *Removing a Postal Inscription* - use the **Review** keys to scroll to **None** and press **Enter/yes**. A message displays confirming your choice and the main screen displays without the inscription.

If you have PC Meter Connect, refer to [Adding or Removing Postal Inscriptions using PC Meter Connect](#).

## Purchasing other Postal Inscriptions for your Machine

Your machine comes pre-loaded with two postal inscriptions. If you want another inscription, contact Pitney Bowes, see [Pitney Bowes Contact List](#). Inscriptions can be purchased and downloaded directly into your machine.

# 4 - Running Mail

Power up the Machine.....	19
Checking the Amount of Postage Available.....	19
Determine the Amount of Postage Needed.....	19
Do You Need Add-On USPS Services?.....	20
Applying Postage: Entering it Manually.....	20
Applying Postage Using Optional Internal Rating.....	21
Applying Postage Using Optional Scale and Internal Rating.....	22
Applying Postage Using Weight Hold Mode.....	23

## Power up the Machine

When you power up your system, the Home screen appears on the operating display. If your system has been set up to require a Lock Code or password, you are prompted to enter it.

A typical Home screen is shown below (with optional scale connected and optional internal rating feature).

## Checking the Amount of Postage Available

1. Press **Funds**. The amount remaining in the machine displays.
2. Use the **Review** keys to scroll until "Check amt available to download?" appears in the display, then press **Enter/yes**.
3. The meter dials or connects to the PB Data Center - Postage by Phone and displays the amount available to download. If you need to purchase additional postage, refer to [Adding Postage to Your Machine](#).
4. Press **Clear/Back** to return to the main screen.

If you have PC Meter Connect, refer to [Checking the Postage Amount Using PC Meter Connect](#).

## Determine the Amount of Postage Needed

The amount of postage required for a mail piece is based on USPS regulations and includes the following factors:

- class of mail (how fast you want the mail piece delivered )
- weight
- shape (for certain size letters and all packages)

### Calculate the Postage Manually

If you need to calculate the postage manually, please contact your local Post Office or go to [www.usps.com](http://www.usps.com) for the latest rates and fees. Based on those rates and fees and the above factors you can determine the exact postage and can key that amount into the machine. Refer to [Entering Postage Amount Manually](#).

### Use the Optional Internal Rating to Calculate the Postage

If you have purchased the optional internal rating feature, the machine can calculate the postage for the mail pieces based on the weight you provide. Refer to [Using the Optional Internal Rating to Calculate Postage](#).

### Use the Optional Scale with Optional Internal Rating to Calculate Postage

If you have purchased the optional scale and optional internal rating feature, the machine can calculate the postage required for the mail piece. Refer to [Using the Optional Scale and Internal Rating to Calculate Postage](#).

### Use the Weight Hold Mode

If the size of the mail piece covers the display screen on the machine, you can use the Weight Hold Mode to rate the mail piece. When you use this mode, the machine holds the weight in memory until you select a class and finish the rating process. Refer to [Using the Weigh Hold Mode to Apply Postage](#).

## Do You Need Add-On USPS Services?

If you want to use any of the optional add-on USPS Services (such as insurance, COD, Delivery Confirmation, Signature Confirmation, Return Receipt, etc.), please contact your local Post Office to complete the postage process. You will have to attach specific labels and/or fill out forms and pay additional fees to include these services on your mail piece.

## Applying Postage: Entering it Manually

1. Enter the postage amount using the numeric keys and press **Enter/Yes** (you do not have to enter the decimal point).

- Slide the envelope (or tape sheet if the mail piece is too large for the machine) into the mail deck. The machine prints the digital indicia and signals when to remove the mail piece.



## Applying Postage Using Optional Internal Rating

Use this method when:

- You already know the weight of a mail piece and you are not using the optional scale.
  - You are using the optional scale and the weight of the mail piece exceeds that weight limit of the scale (2 or 5 lbs., depending on model).
- Press **Menu**.
  - Use the Review keys to scroll to "Type in a Weight?" and press **Enter/yes**.
  - Key in pounds and press **Enter/yes**.

4. Key in ounces and press **Enter/yes**.

---

**NOTE 1:** If no class is displayed when you placed the mail piece on the mail deck, you may need to scroll and select the class. If you are not sure of the class, call your local post office or visit [www.usps.com](http://www.usps.com). If you do not specify a class, the machine will select a class based on the weight of the mail piece.

**NOTE:** The machine allows you to enter either a ZIP Code or a Zone number for those USPS classes that require a destination entry (e.g., Priority class over 1 lb.). When prompted to enter a ZIP or Zone in these cases, you may either key in the 5-digit ZIP Code or one-digit Zone number (0-8). The ZIP/Zone you enter must represent the ZIP/Zone of the mail piece destination, not the machine.

---

5. The display shows the final postage amount and the class.
6. Slide the envelope (or tape sheet if the mail piece is too large for the machine) into the mail deck. The machine prints the digital indicia and signals when to remove the mail piece.

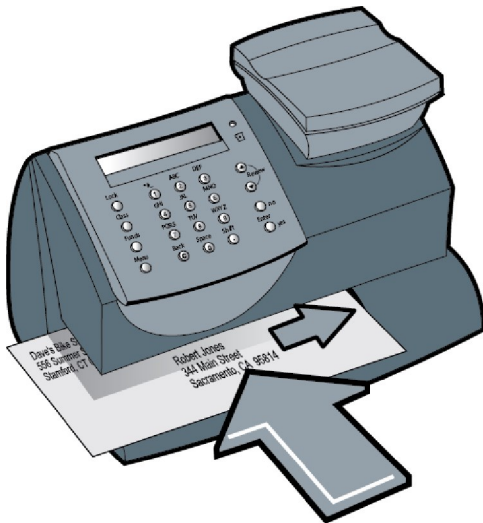

## Applying Postage Using Optional Scale and Internal Rating

Use this method when you are using the optional scale and optional internal rating.

1. Place the mail piece on the scale. The weight of the mail piece appears on the display.

---

**NOTE:** If no class is displayed when you placed the mail piece on the mail deck, you may need to select the class. If you don't know the class, contact your local post office. If you do not specify a class, the machine will select a class based on the weight of the mail piece.

**NOTE:** The machine allows you to enter either a ZIP Code or a Zone number for those USPS classes that require a destination entry (e.g., Priority class over 1 lb.). When prompted, you may key in the 5-digit ZIP Code or one-digit Zone number (0- 8). The ZIP/Zone you enter must represent the ZIP/Zone of the mail piece destination, not the machine.

---

2. The display shows the final postage amount and the class.
3. Slide the envelope (or tape sheet if the mail piece is too large for the machine) into the mail deck. The machine prints the digital indicia and signals when to remove the mail piece.



## Applying Postage Using Weight Hold Mode

Use the Weight Hold Mode if the size of the mail piece covers the display screen on the machine. When you use this mode, the machine holds the weight in memory until you select a class and finish the rating process.



In order to use this mode you need to first activate it using System Settings. To access System Settings, use the **Menu** key on the control panel. Refer to [Setting Up the Weight Hold Mode](#) for more information.

When using this mode:

- "WH" displays when the weight is in memory.
- The weight remains for 10 seconds after the piece is removed.
- To extend the time, press **Enter/yes**.
- To clear the weight before the 10 seconds finish, press **Clear/Back**.

# 5 - Using the Batch Mail Count Feature

Viewing the Batch Mail Count .....	26
Printing the Batch Count .....	27
Clearing the Batch Count .....	27

## Viewing the Batch Mail Count

Your system can keep track of batches of mail. You can use this feature to track the amount of mail going out per day, per week, per month, etc. The system stores the postage value and piece count information in a "batch register".

To view the batch count:

1. Press **Funds**.
2. Use the Review keys to scroll until you see a screen similar to the one shown here.
3. Press **Clear/Back** to return to the main screen.
4. To print the batch count, refer to [Printing the Batch Count](#). To clear the batch count, refer to [Clearing the Batch Count](#).

## Printing the Batch Count

1. Press **Menu**.
2. Use the **Review** keys to scroll to "Select a report?" and press **Enter/yes**.
3. Use the **Review** keys to scroll to "Print funds report?" and press **Enter/yes**. When prompted, insert an envelope or tape strip into the mail deck. The batch count and batch value are printed (see sample below).
4. When prompted to stay in reports, press **No** to return to the main screen.

<b>Funds Report</b>	<b>Used:</b> \$031.600	<b>Account No.:</b> 99999999
	<b>Available:</b> \$068.400	<b>Batch Count:</b> 3
	<b>Total Pieces:</b> 29	<b>Batch Value:</b> \$002.720
	<b>Control Sum:</b> \$100.00	<b>PBI Serial No.:</b> 1100024

### Funds Report Description

*Used:* The total of all postage ever used in the meter.

*Available:* The amount of postage remaining in the meter.

*Total Pieces:* The total number of mail pieces run through the machine that had postage applied.

*Control Sum:* The total of all postage refills for the meter and equals the amount Used plus Available. This is a postal requirement that verifies an accurate accounting of the postage in your meter.

*Batch Count:* The number of mail pieces that had postage applied since the last time the batch count was cleared.

*Batch Value:* The amount of postage applied since the last time the batch value was cleared.

*PBP Serial No:* The serial number of this meter (normally meter number).

## Clearing the Batch Count

**IMPORTANT:** Make sure you really want to clear the batch count; once you do, you can't restore the data.

1. Press **Funds**
2. Use the **Review** keys to scroll to "Reset batch postage and pieces?" and press **Enter/yes**.
3. Press **Enter/yes** to confirm that you want to clear these value. The values return to zero.
4. Press **Clear/Back** to return to the main screen.

# 6 - Accounting

About accounts.....	30
Turning Accounts On and Off.....	31
Creating an account.....	31
Editing an account name and password.....	32
Selecting an account.....	33
Viewing Account Totals.....	33
Printing an Account Report.....	33
Clearing All or Some of the Accounts.....	34
Deleting an account.....	35

## About accounts

The optional accounting feature on the machine allows you to track your postage costs by account categories. Use accounts to identify and track mailing expenses for your organization. Common account categories include departments, people, locations and projects. Use accounts to manage and budget your postal costs efficiently.

The system provides the following accounting options:

- Standard Accounting Option - 5 Accounts  
This base option allows you to track postage for five accounts.
- Standard Accounting Option - 10 Accounts  
This option allows you to track postage for 10 accounts.

Your machine stores the following information for each account:

- An **account name** up to 14 alphanumeric characters long
- An **account number**
- The **item total**, or the total number of pieces of mail charged to an account since the account was last cleared.
- The **value total**, or the total amount of postage charged to an account since the account was last cleared.
- An **account password** (optional)

## Turning Accounts On and Off

1. Press **Menu**.

- *Turning Accounting ON* - select "Turn Accounting On?" and press **Enter/yes**. Follow the prompts for either *creating an account* (if this is the first time using the feature) or *selecting an account*.

---

**NOTE 1:** The "Turn Accounting On?" option will only display if you have ordered and downloaded the optional Accounting feature. If you have not, contact your sales representative to purchase it and then download it by connecting to the Data Center.

**NOTE 2:** You will not be tracking postage by account when this feature is turned off.

- *Turning Accounting OFF* - scroll to "Use accounting functions?" and press **Enter/yes**. Use the **Review** keys to scroll to "Turn off accounting?" and press **Enter/yes**. A confirming message displays. Press **Enter/yes** to continue.

2. Follow the prompts to add another account if turning ON accounting or press **Clear/Back** to return to the main screen.

---

**NOTE:** Once you turn on the accounting feature, you must select an account before you can print postage. In addition, if you have assigned a password to the account you must enter that 4-digit password before proceeding

---

## Creating an account

You can use the accounting feature to track the postage that departments or individuals within your company use.

1. Press **Menu**.
2. Use the **Review** keys to scroll to **Use accounting functions**.
3. Press **Enter/Yes**.
4. Use the **Review** keys to scroll to **Create an account**.
5. Press **Enter/Yes**.



6. Enter the name of this account and press **Enter/Yes**.  
The name can be up to 14 alpha-numeric characters long. To access alpha characters, tap the appropriate number key until the character appears.
7. (Optional) You can assign a four digit password to this account. Enter the password.
8. Press **Enter/Yes**.
9. Re-enter the password to confirm.
10. Follow the prompts to either add another account, stay in the Accounting menu, or return to the Home screen.

### Related topics

- [Using the accounting feature](#)
- 

## Editing an account name and password

Edit an account when you want to change the account name or password.

1. Press **Menu**.
2. Use the **Review** keys to scroll to **Use accounting functions?**.
3. Press **Enter/yes**.
4. Use the **Review** keys to scroll to **Edit an existing account?**.
5. Press **Enter/yes**.
6. Use the **Review** keys to scroll to the account you want to edit and press **Enter/yes**. If you have assigned a password to this account you are prompted for it. Enter in the 4-digit password and press **Enter/yes**.
7. Depending on how the account was set up, you can do one of the following:
  - Edit Account Name - follow the prompts to change name.
  - Assign a Password to Account (if none has yet been assigned) - follow the prompts to assign a 4-digit password. Re-enter password to confirm.
  - Edit Account Password - follow the prompts to change password.
  - Delete Account Password - follow the prompts to delete password.
8. Follow the prompts to edit another account or return to the Accounting menu. Follow the prompts to return to the Main screen.

### Related topics

- [Turning Accounting on or off on the mailstation series](#)

## Selecting an account

When you use accounting on your meter, you must select an account before you can print postage.

1. Press **Menu**.
2. Press **Review (down)** until to **Change account?** appears.
3. Press **Enter/Yes**.
4. Scroll and select the account you want. If the account uses a password, the meter prompts you to enter it. After you enter the 4-digit password, a confirmation message appears, and the meter returns to the Home screen.

### Related topics

- [Turning Accounting on or off on the mailstation series](#)

## Viewing Account Totals

1. Press **Menu**.
2. Use the **Review** keys to scroll to "Use accounting functions?" and press **Enter/yes**.
3. Use the **Review** keys to scroll to "View account postage and pieces?" and press **Enter/yes**.
4. Use the **Review** keys to scroll to the account you want . The postage and number of pieces for this account are displayed.
5. Press Clear/Back to return to the Accounting menu. Follow the prompts to return to the main screen.

If you have PC Meter Connect, refer to [Viewing Account Totals using PC Meter Connect](#).

## Printing an Account Report

Follow these steps to print an account report:

1. Press **Menu**.
2. Use the **Review** keys to scroll to "Use accounting functions?".
3. Press **Enter/yes**.
4. Use the **Review** keys to scroll to "Print an account report?".
5. Press **Enter/yes**.

6. Select "Print Single Report" or "Print Multiple Report" and press **Enter/yes**. Depending on how the account was set up, you can do one of the following:

Print Single Report - use the **Review** keys to scroll the account you want and press **Enter/yes**. When prompted insert an envelope or tape strip.

Account Report	Acct Name: Sales	1100024
	Acct Number: 1	MAY 26 09
	Pieces: 3	12:28 p
	Postage: \$024.550	

### Single Account Report

**Print Multiple Report** - All accounts will be printed. Insert envelope or tape strip.

Account Summary	Account No.:	Pieces:	Postage:	1100024
	1	5	\$024.550	MAY 26 09
	2	8	\$067.470	12:28 P
	3	9	\$009.600	

### Multiple Account Report

## Clearing All or Some of the Accounts

You can clear the postage totals on an account when necessary (for example, at the end of a fiscal year).

---

**IMPORTANT:** Make sure you really want to clear an account. Once you do, the account information is gone. We suggest you print an accounting report first (see previous topic) before clearing.

---

1. Press **Menu**.
2. Use the **Review** keys to scroll to "Use accounting functions?" and press **Enter/yes**.
3. Use the **Review** keys to scroll to "Clear account value and pieces to zero" and press **Enter/yes**.

4. Select **All** or **One** account to clear and press **Enter/yes**.
  - *Clear All Accounts* - Confirm that you want to clear all when prompted.

---

**NOTE:** If you have assigned a password to any of the accounts you will not be able to clear all of the accounts using this option.

---

- *Clear One Account* - Use the **Review** keys to scroll to the account you want to clear and press **Enter/yes**. Confirm that you want to clear the account when prompted.

---

**NOTE:** If you have assigned a password to this account you are prompted for it. Enter in the 4-digit password and press **Enter/yes**.

---

5. Follow the prompts to clear another account or return to the Accounting menu. Follow prompts to return to the main screen.

## Deleting an account

You can delete an account when necessary (for example, at the end of a fiscal year).

**Important:** Make sure you do not need an account's data before you delete an account. When you delete an account, you delete its data. You cannot recover deleted data.

1. Press **Menu**.
2. Use the **Review** keys to scroll to **Use accounting functions?**
3. Press **Enter/Yes**.
4. Use the **Review** keys to scroll to **Delete an account**.
5. Press **Enter/Yes**.
6. Use the **Review** keys to scroll to the account you want to delete and press **Enter/Yes**. If you assigned a password to this account, you are prompted for it. Enter in the 4-digit password and press **Enter/Yes**.
7. Press **Enter/Yes** to confirm that you want to delete the account. Follow the prompts to delete another account or return to the Accounting menu.
8. Press **Clear/Back** to return to the Home screen.

# 7 - Reports

About Reports .....	37
Printing a funds report .....	37
Printing your Last 5 Refills summary report .....	38
Printing an Account Report .....	39
System Software Version Report .....	40
View System Software Versions on Machine Only .....	41

## About Reports

Your machine allows you to view and print reports for funds usage, postage refills, account reports and other valuable data. The printable reports are done right from your machine on an envelope or tape sheet.

For information on printing a funds report, refer to [Funds Report](#).

For information on printing a postage refill report, refer to [Refill Summary Report](#).

For information on printing accounting reports, refer to [Printing an Account Report](#).

## Printing a funds report

Follow these steps to print your funds report:

1. Press **Menu**.
2. Use the **Review** keys to scroll to **Select a report?** and press **Enter/yes**.
3. At **Print Funds Report?**, press **Yes/Enter**.
4. When prompted, insert an envelope or tape sheet into your meter.

5. Your machine prints your funds report, and your system returns to the **Reports** menu.

Press **No** to return to your home screen.

The report is printed (see sample below) and you return back to the reports menu. Follow prompts to return to the the main screen.

Funds Report	Used: \$031.600	Account No.: 99999999	
	Available: \$068.400	Batch Count: 3	MAY 26 13
	Total Pieces: 29	Batch Value: \$002.720	4:33p
	Control Sum: \$100.00	PBI Serial No.: 1100024	

Your Funds Report contains the following pieces of information:

- **Used:** The total amount used over the lifetime of the meter.
- **Available:** The amount currently available to print.
- **Total Pieces:** The total number of pieces run over the lifetime of your meter.
- **Control Sum:** The total of the amount used and available.
- **Batch Count:** The current Batch Count.
- **Batch Value:** The current Batch Total.
- **PBI Serial No.:** The serial number of your meter.
- The date and time you printed your report.

## Printing your Last 5 Refills summary report

Follow these steps to print your Last 5 Refills summary report (Add Postage report):

1. Press **Menu**
2. Use the **Review** button to scroll to **Select a report?**
3. Press **Enter/yes**.
4. Use the **Review** button to scroll to **Print refill summary?**
5. Press **Enter/yes**.
6. When prompted, insert an envelope or tape sheet into your meter. Your machine prints your refill summary report.
7. Your system returns to the Reports menu. Press **No** to return to your main screen.

Last 5 Refills	Date of Refill:	Time:	Refill Amount:	Account No: 99999999
	MAY 23 09	10:25A	\$100.000	Meter No: 1100024
	APR 15 09	4:29P	\$050.000	Printed: MAY 26 09
	APR 02 09	9:04A	\$075.000	
	MAR 15 09	12:29P	\$200.000	
	FEB 23 09	11:32A	\$100.000	

Follow these steps to print your refill summary using PC Meter Connect (K7C2 only):

1. Click on **My Meter**.
2. Click **Refill History**.
3. Click **Print** at lower left of screen.
4. Click **Print** at lower left of screen again.
5. Select the desired printer at the Windows Print screen and click **OK**.

Your Last 5 Refills summary report contains the following pieces of information:

- **Date of Refill:** The date of the postage refill.
- **Time:** The time of the refill.
- **Refill Amount:** The amount of the postage refill.
- **Account No:** Your PB Postage account number.
- **Meter No:** The serial number of your meter.
- **Printed:** The date you printed your report.

## Printing an Account Report

Follow these steps to print an account report:

1. Press **Menu**.
2. Use the **Review** keys to scroll to "Use accounting functions?".
3. Press **Enter/yes**.
4. Use the **Review** keys to scroll to "Print an account report?".
5. Press **Enter/yes**.



6. Select "Print Single Report" or "Print Multiple Report" and press **Enter/yes**. Depending on how the account was set up, you can do one of the following:

Print Single Report - use the **Review** keys to scroll the account you want and press **Enter/yes**. When prompted insert an envelope or tape strip.

Account Report	Acct Name: Sales	1100024
	Acct Number: 1	MAY 26 09
	Pieces: 3	12:28p
	Postage: \$024.550	

### Single Account Report

**Print Multiple Report** - All accounts will be printed. Insert envelope or tape strip.

Account Summary	Account No.:	Pieces:	Postage:	1100024
	1	5	\$024.550	MAY 26 09
	2	8	\$067.470	12:28P
	3	9	\$009.600	
				Page 1 of 1

### Multiple Account Report

## System Software Version Report

This report lists system information about your mailing machine.

1. Press **Menu**.
2. Use the **Review** keys to scroll to "Select a report?" and press **Enter/yes**.
3. Use the **Review** keys to scroll to "Print software version report?" and press **Enter/yes**.
4. When prompted, insert tape sheet or envelope into the machine.
5. The report is printed and you return back to the reports menu. Follow prompts to return to the main screen.

Software Versions	UIC: 9.0.02	Platform: A0.02	0001100024
	PM: 05.20	Rate Data: K7US002B01	MAY 26 09
	PSD SW Version: 05.00.00	Rate Effective: May 12 09	4:33P
	RateMgr: 03.45		

If you have PC Meter Connect, refer to [Printing a System Software Version Report Using PC Meter Connect](#).

## View System Software Versions on Machine Only

This report lists system information about your system on the machine display only - it is not printed.

1. Press **Menu**.
2. Use the **Review** keys to scroll to "Select a report?" and press **Enter/yes**.
3. Use the **Review** keys to scroll to "View software ver. report?" and press **Enter/yes**.
4. Use the **Review** keys to scroll through the screens of information.
5. Press **Clear/Back** to return back to the reports menu. Follow prompts to return to the main screen.

# 8 - Connecting to the Data Centre

About System Settings.....	43
Setting the Contrast of the LCD Display.....	43
Setting System Time.....	43
Using the Preset Feature.....	44
Settings for the Optional Scale.....	46
Setting your Lock Code.....	47
Setting Sleep Mode Activation Time.....	47
Activating the Sleep Mode Manually.....	48
Setting the High Value Warning.....	48
Setting the Low Funds Warning.....	49

## About System Settings

You use system settings to customize your machine to accommodate the way you run mail. You can also add security to those features that are sensitive for your organization. System settings include:

- Setting display contrast
- Setting system time
- Using the preset feature
- Setting/disabling lock code
- Setting sleep mode activation time
- Activating sleep mode manually
- Settings for the optional scale
- Setting a high value warning
- Setting a low funds warning

## Setting the Contrast of the LCD Display

To adjust the LCD display contrast:

1. Press **Menu**.
2. Use the **Review** keys to scroll to "Change set up" and press **Enter/yes**.
3. Use the **Review** keys to scroll to "Change display contrast?" and press **Enter/yes**.
4. Use the **Review** keys to select the contrast and press **Enter/yes**.
5. Press **Clear/Back** to return to the main screen.

## Setting System Time

---

**NOTE:** You can change the time back as early as the beginning of the current day, and you can advance the time up to 24 hours (which means you are in the next day).

---

1. Press **Menu**.
2. Use the **Review** keys to scroll to "Change date and time settings?" and press **Enter/yes**.

3. Use the **Review** keys to scroll to "Change time?" and press **Enter/yes**.
4. Use the **Review** keys to advance or set back the time shown. A message confirms your choice and the main screen displays.

## Using the Preset Feature

### What are Presets

A preset stores commonly used settings for machine values like postage class, postage amount, or any special services. The preset values appear on your machine when it is first powered on or after it awakens from a "sleep" mode.

Using the preset saves time since it generally contains the most commonly printed postage settings for your home or office so you do not have to re-enter those values everytime you run mail.

#### Include the USPS Class in the Preset

When setting up the preset, be sure to include the USPS class. This ensures that whenever there is a USPS rate change and you download the new rates to your mailing machine, your preset will be automatically updated with the new rate.

---

#### **IMPORTANT:**

- You cannot delete the preset but you can redefine new values for the preset based on the current condition of your machine.
- When a rate change becomes effective, check the postage value assigned to the preset to ensure it complies with the new rates.

---

### Turning the Preset Feature On or Off

1. Press **Menu**.
2. Use the **Review** keys to scroll to "Change setup?" and press **Enter/yes**.

3. Use the **Review** keys to scroll to "Use preset setup?" and press **Enter/yes**.
  - *Turning Preset ON* - Press **Enter/yes** at "Turn preset ON?" prompt. A message confirms your choice. You may view the preset values if you wish. When finished, press **Clear/Back** twice and follow prompts to return to the main screen.
  - *Turning Preset OFF* - Use the **Review** keys to scroll to "Turn preset Off?" and press **Enter/yes**. A message confirms your choice. Press **No** to return to the main screen.
4. If you have turned on the preset feature, the main screen reflects the preset settings. If you have turned off the preset feature, the normal main screen displays.

If you have PC Meter Connect, refer to [Turning the Preset Feature On/Off using PC Meter Connect](#).

## Viewing the Preset

1. Press **Menu**.
2. Use the **Review** keys to scroll to "Change setup?" and press **Enter/yes**.
3. Use the **Review** keys to scroll to "Use preset setup?" and press **Enter/yes**.
4. At the "View stored preset?" prompt, press **Enter/yes**.
5. Scroll through the preset values of class, ad, inscription, date etc.
6. When done, press **Clear/Back** twice to return to the main screen.

## Storing or Changing the Preset

1. Determine the values for your machine *preset* (postage class, postage amount, or any special services).

---

**NOTE:** If no class is selected, you may save a postage amount as a preset. Once a class is selected, you cannot save a postage amount.

---

2. Press **Menu**.
3. Use the **Review** keys to scroll to "Change setup?" and press **Enter/yes**.
4. Use the **Review** keys to scroll to "Use preset setup?" and press **Enter/yes**.
5. Use the **Review** keys to scroll to "Store new preset?" and press **Enter/yes**. You can either review the settings of the new preset or store them. Select the appropriate option.
6. When prompted, press **Enter/yes** to confirm the new preset values.
7. When finished, follow prompts to return to the main screen.

## Settings for the Optional Scale

### Resetting the Scale to Zero

You can reset the scale to zero to reduce the chance of accidentally printing the wrong postage.

1. Press **Menu**.
2. Use the **Review** keys to scroll to "Reset the scale to zero" and press **Enter/yes**. The weight on the display returns to 0 lb., 0 oz.

### Setting Up the Weight Hold Method

In order to use the weight hold method, you need to activate it in your machine.

1. Press **Menu**.
2. Use the **Review** keys to scroll to "Change setup" and press **Enter/yes**.
3. Use the **Review** keys to scroll to "Change weight hold setup?" and press **Enter/yes**.
4. Follow the prompts to turn the feature ON or OFF. A confirmation message displays and you return to the main screen.

If you have PC Meter Connect, refer to [Setting up the Weight Hold Method Using PC Meter Connect](#).

### View Metric Weight

You can display a weight in metric values (grams or kilograms) as needed. This is helpful when you are using the internal rating feature and need the weight of an item when sending to a country whose rates are based on metric values.

1. Place the mail piece on the scale.
2. Use the **Review** keys to scroll to "Metric weight xxg". The weight on the scale shows in grams or kilograms.
3. Press **Clear/back** to return to the main screen.

## Setting your Lock Code

The lock code prevents unauthorized access to your system after the machine has been powered up and/or has entered sleep mode.

1. Press **Menu**.
2. Press **Review (down)** to scroll to **Change setup?**.
3. Press **Enter/Yes**.
4. Press **Review (down)** to scroll to **Use lock code setup?**.
5. Press **Enter/Yes**.
6. If a lock code has been established, the meter prompts you to enter the lock code at this point. Enter the four-digit code.
7. Press **Enter/yes**.
8. Press **Review (down)** to scroll to **Turn On Lock Code**.
9. Press **Enter/Yes** at the **Set A Lock Code?** prompt.
10. Enter a four-digit code.
11. Press **Enter/Yes**.
12. Enter the same code again to confirm. A message confirms your choice.
13. Press **No** when asked to **Stay in Setup?** to return to the **Home** screen.

Once a lock code is set, press the Lock button to lock the screen.

Related article

- [Disabling your lock code](#)

## Setting Sleep Mode Activation Time

You can set the amount of time the machine waits until entering "sleep mode". When the machine is in sleep mode, the display is blank (except for the time in the lower right) and you cannot process mail. To awaken the machine, simply press any button on the control panel.

---

**NOTE:** If you have enabled the lock code option, you must enter the lock code to awaken the machine.

---

1. Press **Menu**.
2. Use the **Review** keys to scroll to "Change setup" and press **Enter/ yes**.



3. Use the **Review** keys to scroll to "Change sleep timeout?" and press **Enter/yes**.
4. Key in the desired amount of time (in minutes, from 1 - 20) the machine should be idle before the sleep mode activates and press **Enter/yes**. A message confirms your choices.
5. When prompted to stay in setup, press **No** to return to the main screen.

## Activating the Sleep Mode Manually

You can put the machine into "sleep mode" at any time. When the machine is in sleep mode, the display is blank (except for the time in the lower right) and you cannot process mail. To awaken the machine simply press any button on the control panel.

1. Press **Lock**.
2. At prompt to set system to sleep mode, press **Enter/yes**. The machine enters sleep mode.
3. Press any button on the control panel to awaken the machine.

---

**NOTE:** If you have enabled the lock code option, you must enter the lock code to awaken the machine. The available funds amount displays before returning to the main screen.

---

## Setting the High Value Warning

You can have the machine warn you when you manually key in a postage value that is higher than a maximum amount that you specify. This feature helps prevent you from accidentally printing a postage value that's more than you need.

---

**NOTE:** This warning does not display for postage amounts determined by the internal rating feature. For more information on using the internal rating feature, refer to Applying Postage Using Optional Internal Rating.

---

1. Press **Menu**.
2. Use the **Review** keys to scroll to "Change setup" and press **Enter/ yes**.
3. Use the **Review** keys to scroll to "Change high value warning?" and press **Enter/yes**.
4. Key in the amount of dollars and cents you want the system to use to warn you that you are entering a value equal to or exceeding the high warning amount. Do not enter the decimal point; the system knows the last two digits are for cents. Press **Enter/yes** after you enter the amount.

A message confirms your entry.

5. When prompted to stay in setup, press **No** to return to the main screen.

## Setting the Low Funds Warning

Set your low funds warning value as a reminder to add more postage to your meter.

Follow these steps to set your low funds warning value:

On your meter:

1. Press **Menu**.
2. Press the **Review** arrow keys until the display says **Change Setup?** and press **Enter/Yes**.
3. Press the **Review** arrow keys until the display says **Change low funds warning?** and press **Enter/Yes**.
4. Enter the amount.
5. Press **Enter/Yes**.
6. Press **No** to return to the Home screen.

On your computer, if using PC Meter Connect:

1. Select **My Meter**.
2. Select **Meter Settings**.
3. Select **Warnings**.
4. In the **Low Fund Warning** field, enter the amount (up to \$999999.99) at which you want the system to prompt you with the low funds warning.
5. Select **Apply**.

**Related article:**

- [Adding postage](#)
- [Ajouter des fonds d'affranchissement](#)
- [Adding postage](#)

# 9 - Passwords and Meter Functions

About passwords and meter functions..... 51

## About passwords and meter functions

Passwords can be set up on the machine to prevent unauthorized access to the machine and/or to a specific account. This topic explains the effects on system functions when using either or both types of passwords.

**NOTE:** For information on setting up a password for the mailstation2mailstation, referred to as a Lock Code, refer to [Setting or Disabling the Lock Code](#). For information on setting up a password for an account, refer to [Creating an Account](#).

If you have this:	and have set it to this:	then:
Meter Password (Lock Code)  No Account Passwords activated	Lock Code activated but "Lock on sleep" option is not set.	You must enter the Lock Code password on power-up, or after awakening the machine when the machine was put in sleep mode by pressing <b>Lock</b> .
Meter Password (Lock Code)  No Account Passwords activated	Lock Code activated and "Lock on sleep" option is set	You must enter the Lock Code password on power-up, or after awakening the machine when the machine was put in sleep mode by pressing <b>Lock</b> , or awakening from a time-out induced sleep mode,
Meter Password (Lock Code)  An Account Password has been activated	Lock Code activated but "Lock on sleep" option is not set	You can enter the Lock Code password or an Account password* on power-up, or after awakening the machine when the machine was put in sleep mode by pressing <b>Lock</b> .
Meter Password (Lock Code)  An Account Password has been activated	Lock Code activated <i>and</i> "Lock on sleep" option is set	You can enter the Lock Code password or an Account password* on power-up, or after awakening the machine when the machine was put in sleep mode by pressing <b>Lock</b> , or awakening from a time-out induced sleep mode.

\*Account Password Restrictions - If you enter an Account password to gain access to the machine, the following limitations result:

- The account that you have entered the password for becomes the selected account for printing postage and you will not need to enter the Account password again at that time.

- Change Account, Use Accounting Functions, and Change Setup within the menu are not available. Refill Postage is not available.
- If you want to gain access to all the menu items and the Refill Postage feature, press **Lock** to put the machine in sleep mode, press any button to awaken the machine, and enter the Lock Code password.

# 10 - Connecting to the Data Center

How You Connect to the PB Data Center.....	54
Connect to the PB Data Center with SmartLink Using an Ethernet Cable to a LAN Port.....	56
Connect to PB Data Center with SmartLink Using a Wireless Connection.....	58
Connect to the PB Data Center with the Communication Device Using an Ethernet Cable to a LAN Port.....	60
Connect to the PB Data Center with the Communication Device Using a Wireless Connection..	62
Connect to the PB Data Center with PC Meter Connect Application on your Computer.....	64

## How You Connect to the PB Data Center

In order to download postage to your meter and perform updates (postal rate updates, inspections and system updates) on your machine, you must connect to the Pitney Bowes Data Center.

Your meter can connect to the Pitney Bowes Data Center using one of the following methods: **SmartLink**, the **Communication Device**, or **PC Meter Connect**

### Two Ways to Connect Using SmartLink

1. *Connect Using the SmartLink device with an Ethernet Cable to a LAN Port.*
2. *Connect Using the SmartLink device with a Wireless Connection.*

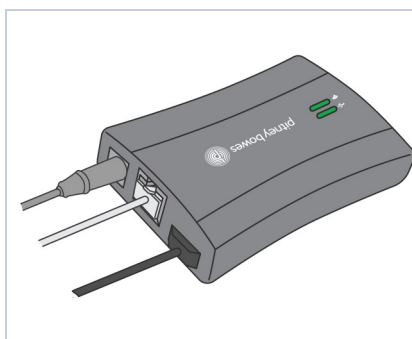

These methods require that the machine be connected to SmartLink. The communications between the machine and the PB Data Center go through the SmartLink device in both of these methods.

When you link your meter to the Pitney Bowes Data Center through SmartLink, you can access the full benefits of SmartLink including:

- Automatic USPS rate updates and software updates
- Low ink and low fund notifications, and simplified ink ordering.
- Remote diagnostics with support and error troubleshooting notifications
- Customized insights on meter and postage usage
- Adding postage to your meter from your computer

## Two Ways to Connect Using the Communication Device

1. *Connect Using the Communication Device with an Ethernet Cable to a LAN Port.*
2. *Connect Using the Communication Device with a Wireless Connection.*

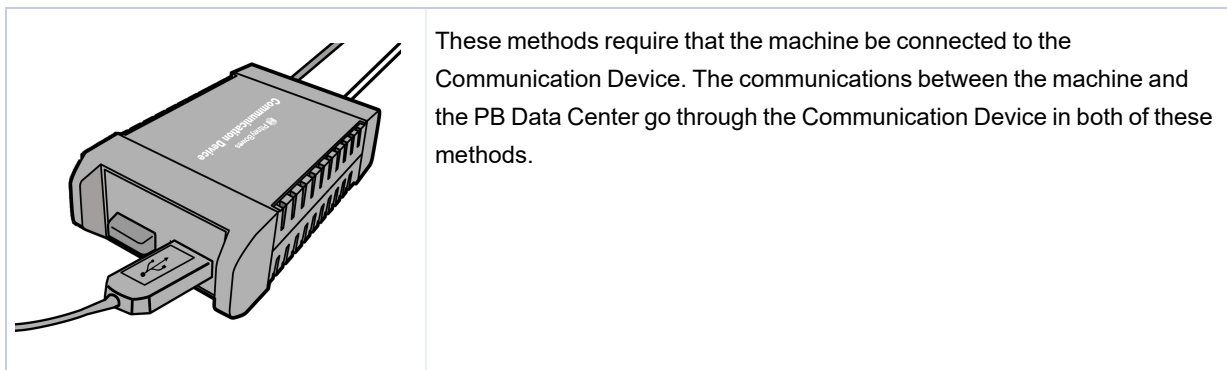

## Connect Directly Through Your Computer Using PC Meter Connect

1. *Connect Using PC Meter Connect with a USB cable to your PC computer*

This method connects the machine directly to a PC that has PC Meter Connect software installed. No additional hardware, such as SmartLink or the Communication Device is used.

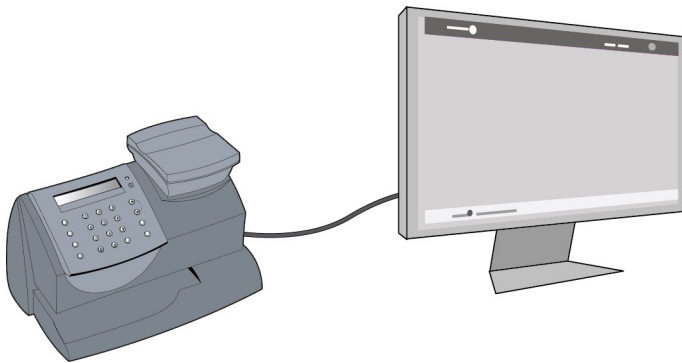

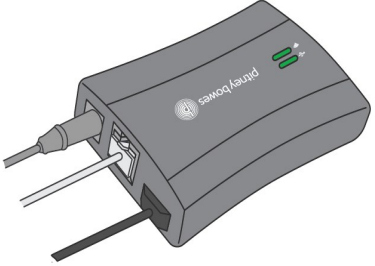

## Connect to the PB Data Center with SmartLink Using an Ethernet Cable to a LAN Port

Item	Description
 A small, grey, rectangular SmartLink device with a power jack on the left, a LAN port in the center, and a power button on the right. The device has the Pitney Bowes logo and the word 'SmartLink' printed on its top surface.	<b>SmartLink</b> device

This method connects the digital postage meter to the internet through the SmartLink device using an Ethernet cable. Installation takes about 10 minutes.

**When you link your meter to the Pitney Bowes Commerce Cloud using the SmartLink device, you can access the full benefits of SmartLink including:**

- Automatic USPS rate updates and software updates
- Low ink and low fund notifications, and simplified ordering
- Remote diagnostics with support and error troubleshooting notifications
- Customized insights on meter and postage usage
- Adding postage to your meter from your computer

## The Connections Between the Digital Postage Meter and the SmartLink Device

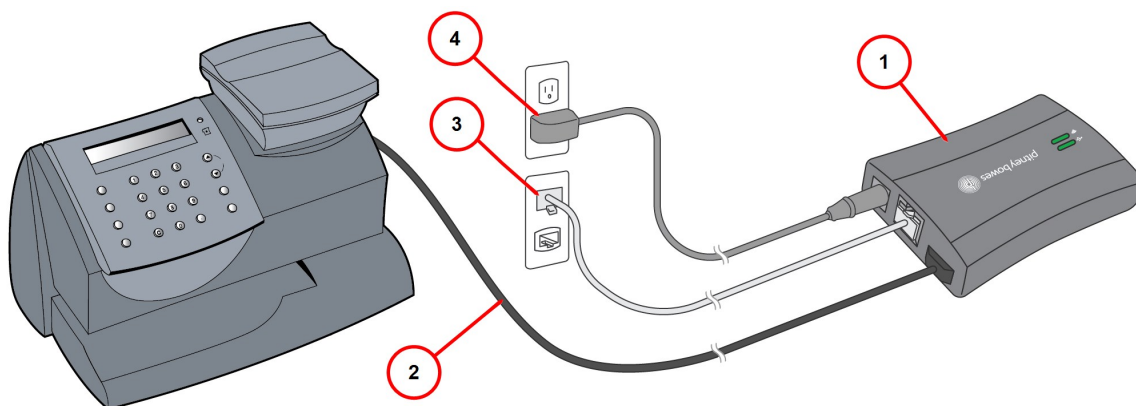

Item	Description
1	SmartLink device
2	USB cable connecting SmartLink device to machine
3	Ethernet LAN cable to router port or network wall outlet (internet connection)
4	AC adapter

For more information and instructions on how to set up this type of connection, refer to the [SmartLink Setup Instructions](#) available on our website.

## Connect to PB Data Center with SmartLink Using a Wireless Connection

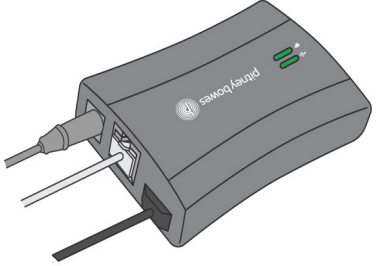
Item	Description
	<b>SmartLink</b> device

This method connects the machine to the internet through the SmartLink device using a wireless connection with blink up technology.

- Wireless installation utilizes 'Blink-up technology'
- Installation takes about 15 minutes
- Requires access to a wireless network

**When you link your meter to the Pitney Bowes Commerce Cloud using the SmartLink device, you can access the full benefits of SmartLink including:**

- Installation takes about 10 minutes
- Requires access to an internet network
- Automatic USPS rate updates and software updates
- Low ink and low fund notifications, and simplified ordering
- Remote diagnostics with support and error troubleshooting notifications
- Customized insights on meter and postage usage
- Adding postage to your meter from your computer

## The Connections Between the Digital Postage Meter and the SmartLink Device

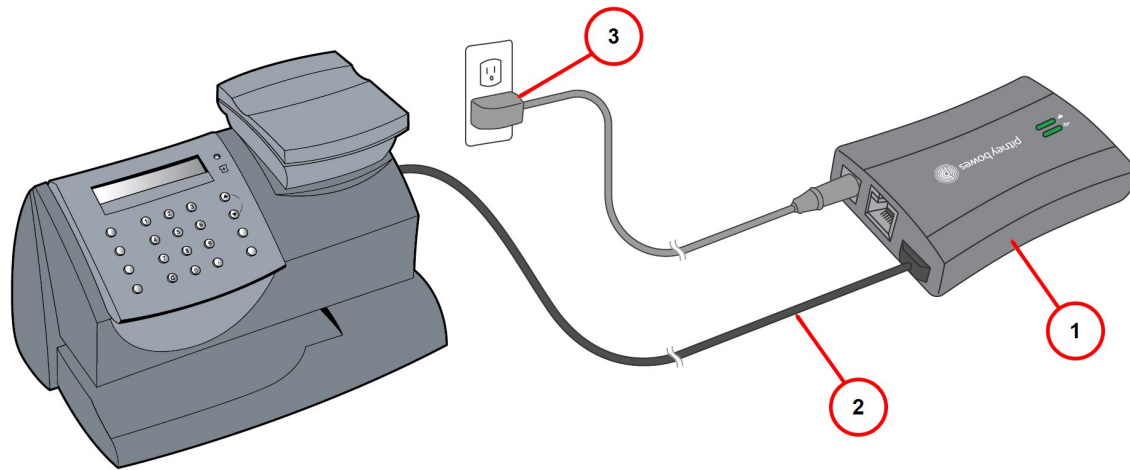

Item	Description
1	SmartLink device
2	USB cable connecting SmartLink device to machine
3	AC adapter

For more information and instructions on how to set up this type of connection, refer to the [SmartLink Setup Instructions](#) available on our website.

## Connect to the PB Data Center with the Communication Device Using an Ethernet Cable to a LAN Port

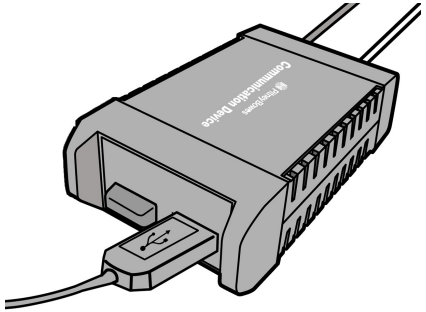
Item	Description
	<b>Communication Device</b>

This method connects the machine to the internet through the Communication Device using an Ethernet cable.

- One end of the Ethernet cable is plugged into the Communication Device and the other end into a router port or network wall outlet (internet connection)
- The machine connects to the Communication Device using a USB cable.
- The machine also comes with a wireless USB plug-in. This is pre-installed in one of the USB ports. Do not remove this plug-in.

## The Connections Between the Digital Postage Meter, the Communication Device and the Internet Source

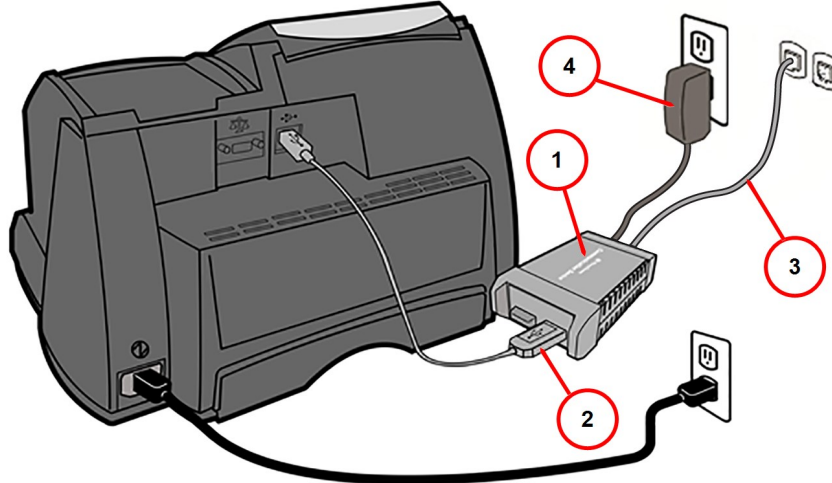

Item	Description
1	Communication Device
2	USB cable connecting Communication device to machine
3	Ethernet cable to network LAN port
4	AC adapter

For more information on setting up this type of connection, refer to [How to install a wired LAN Connection on the mailstation and mailstation2](#) available on our website.

## Connect to the PB Data Center with the Communication Device Using a Wireless Connection

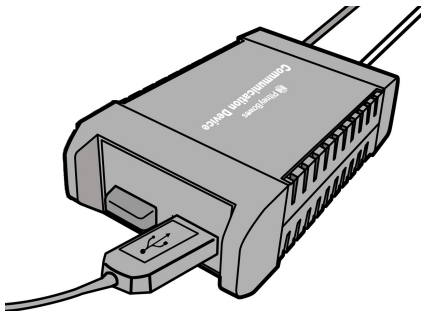
Item	Description
 A grey, rectangular communication device with a USB port on the front and a wireless antenna on the top. The device is shown with a USB cable plugged into the front port. The text "Communication Device" is printed on the top surface.	<b>Communication Device</b>

The Communication Device allows you to connect to the PB Data Center through the internet using a wireless connection.

- The machine connects to the Communication Device using a USB cable.
- The machine also comes with a wireless USB plug-in. This is pre-installed in one of the USB ports. Do not remove this plug-in.

## The Connections Between the Digital Postage Meter, the Communication Device and the Internet Source

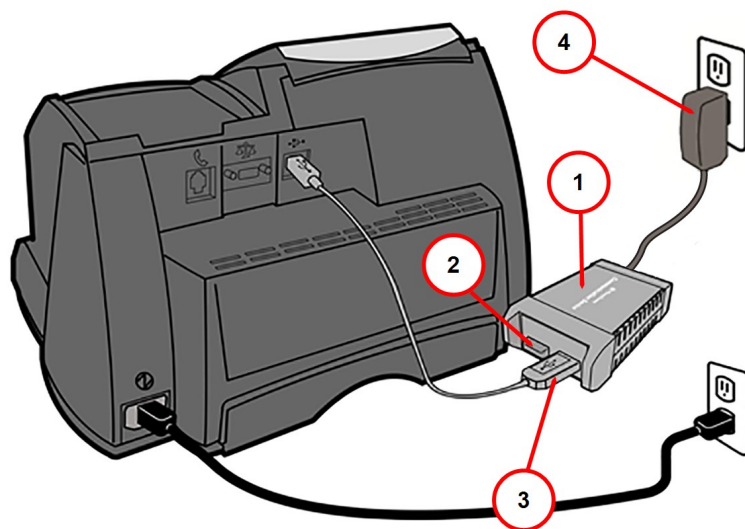

Item	Description
1	Communication Device
2	Wireless USB plug-in (pre-installed)
3	USB cable connecting Communication Device to machine
4	AC adapter

For more information and instructions on setting up this type of connection, refer to the [How to install the mailstation and mailstation2 with a communication device connected through WiFi](#) available on our website.



## Connect to the PB Data Center with PC Meter Connect Application on your Computer

PC Meter Connect™ desktop application is PC-based software that allows you to use your PC computer's high-speed Internet connection to connect your mailing machine to the PB Data Center. A USB cable is provided to connect your machine to a free USB port on a PC running PC Meter Connect.

Using PC Meter Connect directly from your PC allows you to:

- Add postage
- Perform USPS inspections
- Get rate updates

In addition, if you use PC Meter Connect™ during the initial installation of your machine, it will guide you through the entire machine setup process.

---

**NOTE:** No additional hardware, such as SmartLink or the Communication Device is used.

---

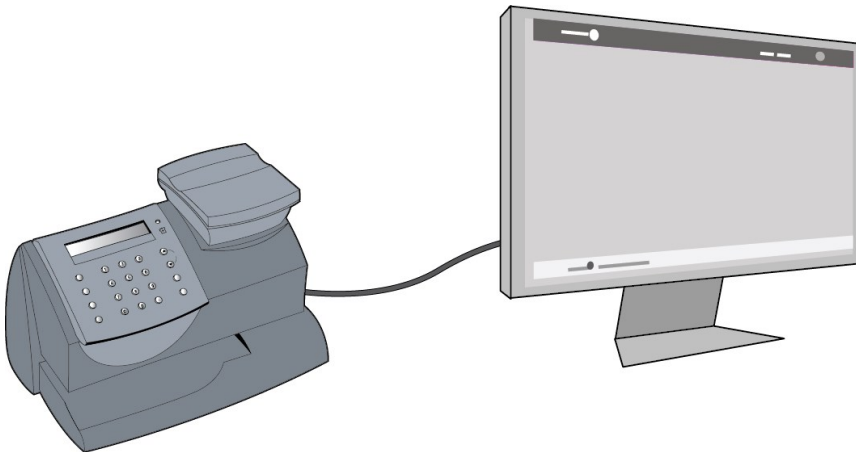

For details on setting up your machine initially using PC Meter Connect, refer to [How to Install PC Meter Connect](#) available on our website.

# 11 - Using PC Meter Connect

Starting PC Meter Connect™.....	66
PC Meter Connect Application Main Window.....	69
Checking the Postage Amount using PC Meter Connect.....	71
Adding Postage using PC Meter Connect.....	71
Downloading new Postal Rates using PC Meter Connect.....	73
Performing Meter Inspections using PC Meter Connect.....	73
Printing a Meter Stamp with an Advanced Date Using PC Meter Connect.....	73
Adding or Removing Ads Using PC Meter Connect.....	74
Adding or Removing Postal Inscriptions using PC Meter Connect.....	74
Setting the System Time using PC Meter Connect.....	74
Turning the Preset On/Off using PC Meter Connect.....	75
Storing or Changing the Preset using PC Meter Connect.....	75
Viewing the Preset using PC Meter Connect.....	76
Resetting the Scale to Zero Using PC Meter Connect.....	76
Setting up the Weight Hold Method using PC Meter Connect.....	76
Setting the High Value Warning using PC Meter Connect.....	76
Setting the Low Funds Warning using PC Meter Connect.....	77
Viewing Account Totals using PC Meter Connect.....	77
Printing an Account Report using PC Meter Connect.....	77
Printing a Refill Summary Report Using PC Meter Connect.....	78

Viewing a System Software Version Report Using PC Meter Connect .....	78
Checking PC Meter Connect Version.....	78
Network Specifications and Requirements for PC Meter Connect.....	80

## Starting PC Meter Connect™

To open the PC Meter Connect™ Main window, double-click on the desktop icon or the system tray icon.



### Desktop Icon



### Icon in System Tray

PC Meter Connect connects to the PB Data Center and displays the postage amount in your system, your Postage by Phone account balance, your Purchase Power balance, and any updates required.

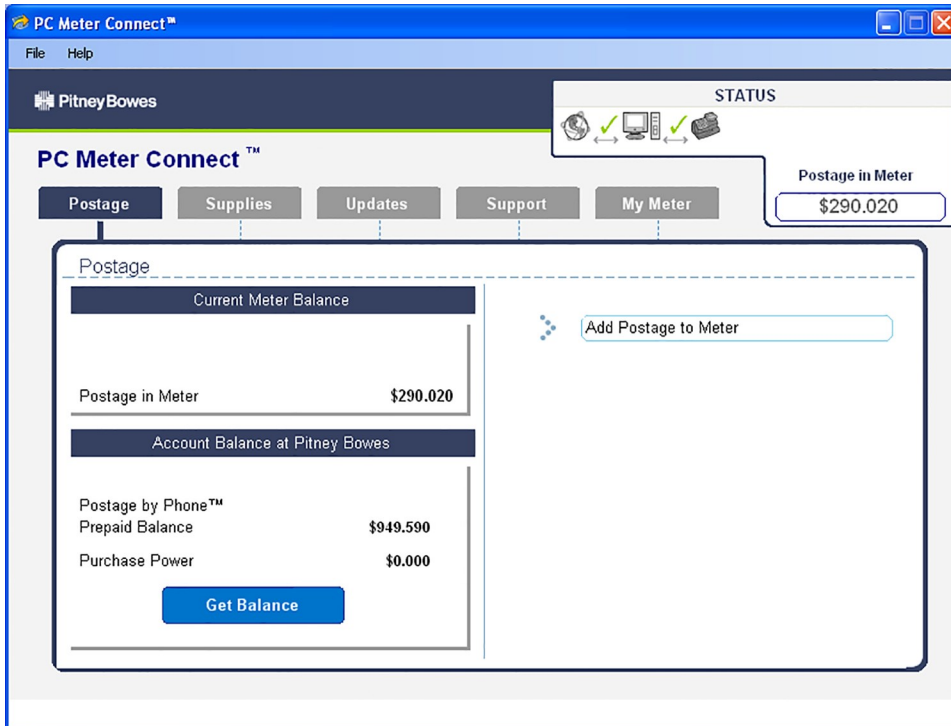

### PC Meter Connect™ Main Window

If you disconnect your machine from the PC the following message displays in the system tray. The red "X" stays in the tray.



### Meter Not Connected Message

When you reconnect your machine to the PC after disconnecting it, the following message displays in the system tray. The red "X" disappears from the tray.



**Meter Detected Message**



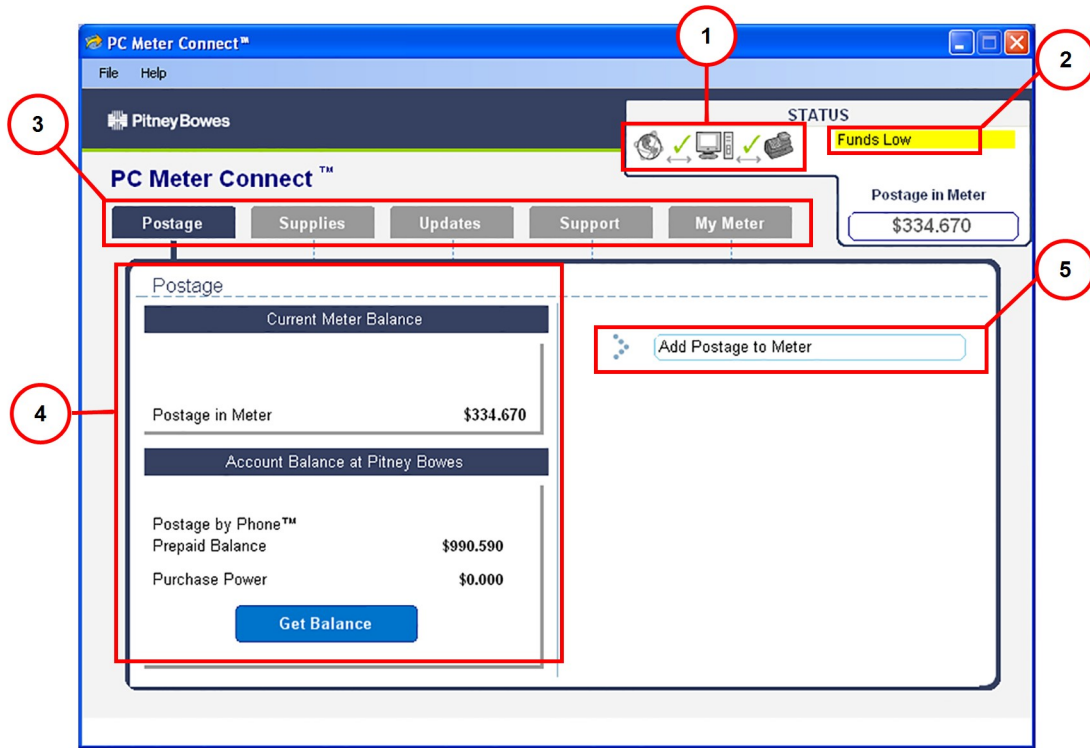

# PC Meter Connect Application Main Window



PC Meter Connect™ Main Window

1. **Connection Status** - indicates whether your PC can communicate with the Internet and to your mailing machine.

A green check ✓ indicates a good connection, while a red X means the devices can not communicate .

	
<b>Good Communication</b>	<b>PC Not Communicating with Machine</b>
	
<b>PC Not communicating with Internet</b>	<b>PC Not Communicating with Internet or Machine</b>

2. **Messages from Meter** - displays status messages (such as "Funds Low") to help you keep your machine operating.
3. **Feature Tabs** - provides access to the PC Meter Connect application features:
  - a. *Postage* - Use this tab to see the postage amount in your system, get your Postage by Phone balance, and your Purchase Power balance. This also allows you to add postage to your machine. Refer to [Adding Postage using PC Meter Connect](#).
  - b. *Supplies* - Use this tab for ordering ink cartridges, E-Z Seal®, envelopes, and other supplies for your machine from the Pitney Bowes On- line Store.
  - c. *Updates* - Use this tab for downloading system updates for your mailing machine, postal inscriptions/envelope ads, perform postal inspections and rate updates.
  - d. *Support* - This tab provides links to the following support functions:
    - My Account on the Pitney Bowes website.
    - Online help on this machine on the Pitney Bowes website.
    - Demonstrations about your machine.
    - PDF of this operator guide.
    - Frequently Asked Questions (FAQs) on this machine on the Pitney Bowes website.
  - e. *My Meter* - This tab allows you to edit machine settings such as the date and time, printing options, and presets etc.

4. **Support Information** - This panel displays the supporting data for the functions of the feature tab. For example, under the Postage tab, this screen displays funds (postage) available in your machine, in your Postage by Phone® account balance, and in your Purchase Power balance.
5. **Task Panel** - This panel lists the tasks you can run from this feature tab. Click on the link to perform the task, for example, Add Postage to Meter.

## Checking the Postage Amount using PC Meter Connect

You can check the funds (postage) in your machine from the Postage tab on the *PC Meter Connect main window*. The Postage tab is the default tab that displays when you launch the program.

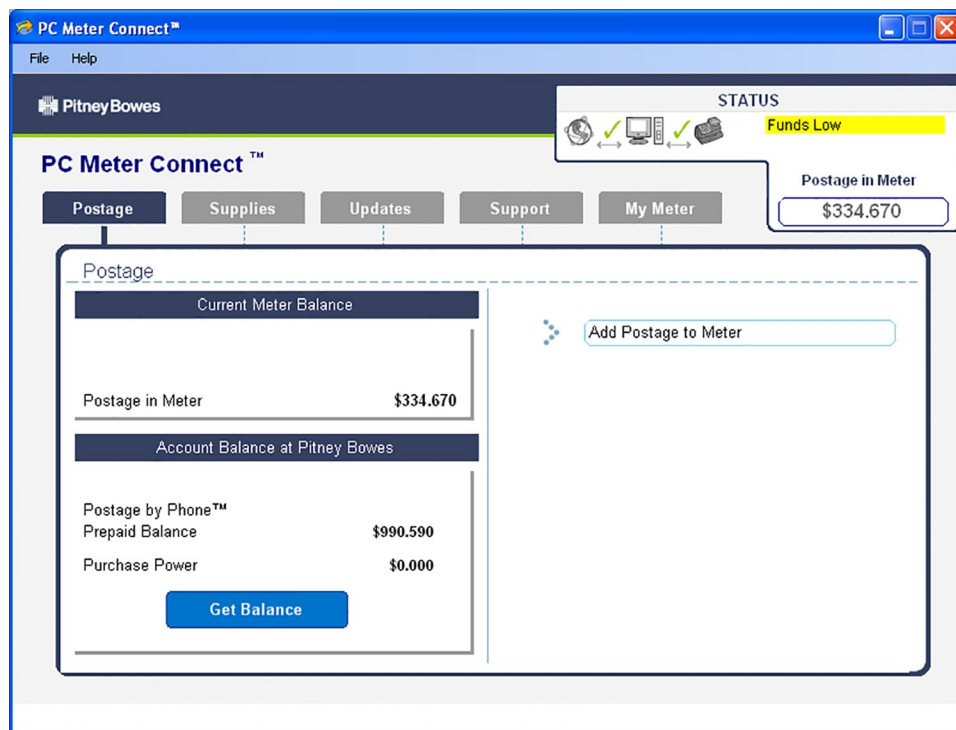

## Adding Postage using PC Meter Connect

You can add postage to your machine any time as long as you have enough funds in your Postage By Phone® system account.



You can add postage to your machine from the Postage tab on the *PC Meter Connect main window*. The Postage tab is the default tab that displays when you launch the program.

1. At the Postage tab, click on **Add Postage to Meter**.
2. Enter in the amount or choose one of the preset amounts. Click **Confirm** to continue.
3. A status bar displays showing the progress of the transaction. Once the postage has been downloaded to your meter you can print a receipt from your PC:
  - a. To bypass the printing of the receipt, click **Skip**.
  - b. To print, click **Print Receipt**. The Refill Receipt screen displays:

Refill Receipt	
Date: 2016 07 04	Time: 10:40 AM
Account Number: 21992987	
Meter Number: 5008416	
Postage in Meter:	\$6.13
Prepaid on Account:	\$0.00
Refill Amount:	\$1.00
Credit Line Available:	\$0.00
<input type="button" value="Print"/> <input type="button" value="Cancel"/>	

#### Description

*Postage in Meter:* Amount of postage (funds) in your meter.

*Prepaid on Account:* Amount you have left in your Postage By Phone® system account of those funds you paid for in advance (by sending in a check, direct withdrawal, etc.).

*Credit Line Available:* Amount you have left in your Postage By Phone® system account of those funds you established as credit with Pitney Bowes (such as Purchase Power®, etc.).

*Refill Amount:* Amount of your refill.

*Account No. :* Your Postage By Phone® system account number.

*Meter No. :* Your meter serial number (on record with the postal service) which is printed on the meter stamp.

4. Click **Print** to continue.
5. Click **Done** when finished.

## Downloading new Postal Rates using PC Meter Connect

1. Select the **Updates** tab from the *PC Meter Connect main window*.
2. Select **Update Software**. The meter checks to see if there are any updates required. The current active rates and any pending rate updates are displayed in the Support Information panel on the left of the screen.
3. When completed the system will prompt you to click **Continue**, then **Done**.
4. If updates are required click on the **Update Software** link in the Task panel on the right side of the screen.

## Performing Meter Inspections using PC Meter Connect

1. Click on the **Updates** tab from the *PC Meter Connect main window*.
2. The meter checks to see if there are any updates required. The current active rates and any pending rate updates are displayed in the Support Information panel on the left of the screen.
3. Click on the **Perform Meter Inspection** link in the Task panel on the right side of the screen.
4. After several minutes, a Meter Inspection Completed screen displays.
5. Click **Ok**.

## Printing a Meter Stamp with an Advanced Date Using PC Meter Connect

1. Click on the **My Meter** tab from the *PC Meter Connect main window*.
2. Select **Meter Settings**
3. Select **Date and Time**.

4. Access the dropdown calendar from within the **Print Date** field. Use the < or > keys to select the month, then click the day you want to print on the meter stamp.
5. Click **Apply**. A confirmation screen displays the new date. Click **OK**.
6. To reset the date on your mail back to the current date, repeat steps 1 - 5 and select today's date.

## Adding or Removing Ads Using PC Meter Connect

1. Click on the **My Meter** tab from the *PC Meter Connect main window*.
2. Select **Meter Settings**.
3. Select **Ads & Inscriptions**.
4. Select the ad you want by clicking in the **Envelope Ads** field and selecting it from the dropdown list.
5. Click **Apply**.

## Adding or Removing Postal Inscriptions using PC Meter Connect

1. Click on the **My Meter** tab from the *PC Meter Connect main window*.
2. Select **Meter Settings**.
3. Select **Ads & Inscriptions**.
4. Select the inscription you want by clicking in the **Inscriptions** field and selecting it from the dropdown list. You can also remove an inscription by selecting the blank option. The inscription you select displays on the screen.
5. Click **Apply**.

## Setting the System Time using PC Meter Connect

1. Click on the **My Meter** tab from the *PC Meter Connect main window*.
2. Select **Meter Settings**.

3. Select **Date and Time**.
4. In the **System** field on the left side of the screen, place your cursor over the day, hour or minute and use the **^** or **v** keys to select the time/date of your machine.
5. Click **Apply** and a confirmation screen displays the new time. Click **OK**.

## Turning the Preset On/Off using PC Meter Connect

1. Click on the **My Meter** tab from the *PC Meter Connect main window*.
2. Click **Meter Settings**.
3. Click on either **View Preset** or **Change Preset**.
4. At the **Preset** field, select **Yes** or **No** from the dropdown to activate or deactivate the preset.
5. Click **Ok** or **Save**.

## Storing or Changing the Preset using PC Meter Connect

1. Click on the **My Meter** tab from the *PC Meter Connect main window*.
2. Click **Meter Settings**.
3. Click **Change Preset**. A Change Preset screen displays.
4. Determine the values for your machine *preset* (postage class, postage amount, or any special services).

---

**NOTE:** If no class is selected, you may save a postage amount as a preset. Once a class is selected, you cannot save a postage amount.

---

5. When finished, click **Save Preset**.
6. At the preset stored confirmation screen, click **OK**.

## Viewing the Preset using PC Meter Connect

1. Click on the **My Meter** tab from the *PC Meter Connect main window*.
2. Click Meter Settings.
3. Click on **View Preset**.

## Resetting the Scale to Zero Using PC Meter Connect

1. Select the **My Meter** tab from the *PC Meter Connect main window*.
2. Click **Reset Scale to Zero**. A "Scale has been recalibrated" message displays.

## Setting up the Weight Hold Method using PC Meter Connect

1. Select the **My Meter** tab from the *PC Meter Connect main window*.
2. Click **Meter Settings** in the Task panel on the right side of the screen.
3. Click **Weight Hold** in the Task panel on the right side of the screen.
4. At the **Weight Hold** field, select from the dropdown choices **Yes** to activate it or **No** to deactivate it.
5. Click **Apply** to save the changes. A confirmation message displays.

## Setting the High Value Warning using PC Meter Connect

1. Select the **My Meter** tab from the *PC Meter Connect main window*.
2. Click **Meter Settings** in the Task panel on the right side of the screen.
3. Click **Warnings**.
4. Enter a value up to \$99,000 in the **High Value Warnings** field for which you want the system to prompt you with the high warning message.
5. Click **Apply**.

## Setting the Low Funds Warning using PC Meter Connect

1. Select the **My Meter** tab from the *PC Meter Connect main window*.
2. Click **Meter Settings** in the Task panel on the right side of the screen.
3. Click **Warnings**.
4. Enter a value up to \$99,000 in the **Low Funds Warnings** field for which you want the system to prompt you with the low funds warning message.
5. Click **Apply**.

## Viewing Account Totals using PC Meter Connect

1. Select the **My Meter** tab from the *PC Meter Connect main window*.
2. Click **Account Reports** on the right side of the screen in the task panel. A report displays listing the postage amount and the number of pieces for each account.

## Printing an Account Report using PC Meter Connect

1. Select the **My Meter** tab from the *PC Meter Connect main window*.
2. Click **Account Reports** on the right side of the screen in the task panel.
3. Click **Print** at the lower left side of the screen.
4. Click **Print** again at the bottom of the Account Report screen.
5. Select your printer at the Windows Print screen and then click **OK**.

## Printing a Refill Summary Report Using PC Meter Connect

1. Select the **My Meter** tab from the *PC Meter Connect main window*.
2. Click **Refill History** on the right side of the screen in the task panel.
3. Click **Print** at the lower left side of the screen.
4. Click **Print** at the lower left side of the screen again.
5. Select your printer at the Windows Print screen and then click **OK**

## Viewing a System Software Version Report Using PC Meter Connect

1. Select the **Updates** tab from the PC Meter Connect main window. The
2. Click **Details >>** for more details on the system levels in your mailing system. To hide the details click **<< Hide**.

## Checking PC Meter Connect Version

You may get an error message on the control panel display indicating that you are running a version of PC Meter Connect that is not compatible with the version of software running on your machine. This topic shows how to check the version of PC Meter Connect loaded on your PC.

1. Right click on your PCMC icon in the system tray on your PC.



2. Left click **About PC Meter Connect** to find out what PC Meter Connect version you are currently running.

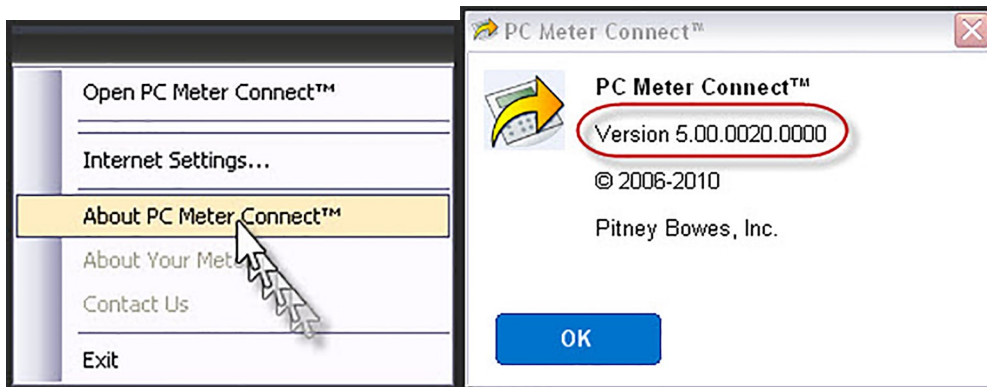

3. For best performance, set your Protocol (as shown in the Internet Settings of PCMC) to HTTPS Mode.
  - a. Select **File > Internet Settings**.
  - b. Select Non-Chunked as the HTTP Transfer Encoding Method.
  - c. Click OK.

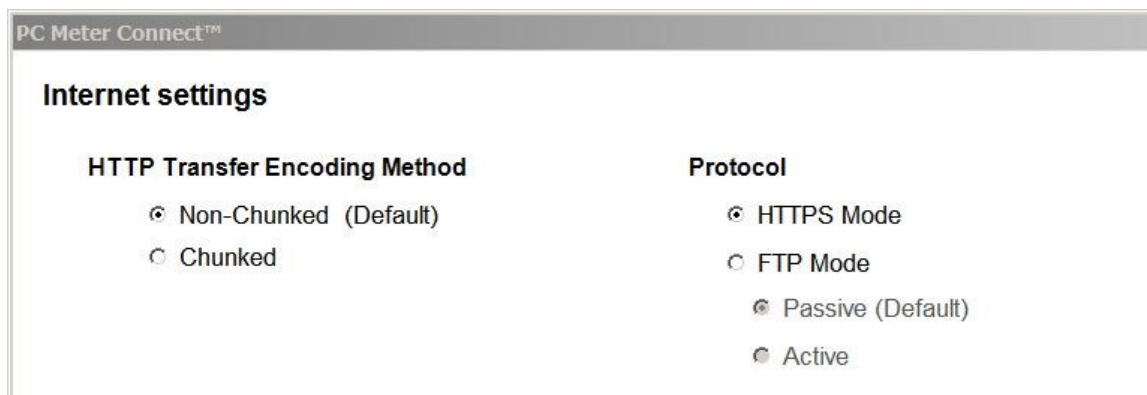

4. If you need to update the version of your PC Meter Connect software, visit [www.pb.com/support/PCMC](http://www.pb.com/support/PCMC).



# Network Specifications and Requirements for PC Meter Connect

PC Meter Connect™ desktop application is PC-based software that allows you to use your PC's high-speed Internet to connect your mailing machine to the PB Data Center, as well as provide convenient access to mailing machine settings from your PC. A USB cable is provided to connect your machine to a free USB port on the back of the PC running PC Meter Connect.

In addition, if you use PC Meter Connect™ during the initial installation of your machine, it will guide you through the entire machine setup process.

## Minimum PC Requirements for PC Meter Connect

- Windows 2000, Windows XP (32-Bits and 64 Bits), Windows Vista (32-Bits and 64 Bits), and Windows 7 (32-Bits and 64 Bits).
- 1.2 GHz processor, 512 Mb RAM.
- USB port.
- Administrative privilege to install software.
- Microsoft .NET framework 2.0 (required for PC Meter Connect) will be automatically installed if it is not ready on the PC. This is a one-time installation.
- Internet Connection.
- Non-Windows Operating Systems, e.g. Mac and Linux, are not supported.

## Network Requirements for the Meter using PC Meter Connect

- The System (Meter and PC Meter Connect desktop application) requires an Internet connection, accessed through a Wired or Wireless LAN.
- The system supports 10/100 Ethernet transfer rates; Full Duplex.
- The system initiates all communication.
- The system initiates all communication via HTTP, HTTPS, and FTP.
- The system communicates to external Web Services via HTTP over Port 80.
- The system communicates to PB secure server(s) via HTTPS over port 443.
- The system communicates to PB data server via FTP, reference port details below.
- The system uses Port 53 for DNS lookup.

## Requirements for Firewall Access

It is recommended that you connect your meter to the internet through a firewall. If your network does not allow unrestricted outbound access you can provide access to Pitney Bowes' servers adding the Pitney Bowes servers to your exception list. Refer to [Exception List](#).

## Frequently Asked Questions

What type of FTP is used by the System, Active or Passive?

FTP may be used if the preferred method, HTTPS is not desired. The PC Meter Connect desktop application will default to FTP "Passive" mode, but you can change the protocol to "Active" if necessary using the Internet Settings menu from the PC Meter Connect desktop application .

To access the Internet Settings menu from PC Meter Connect, select **File > Internet Settings**.

The screenshot shows the 'Internet settings' dialog box in the PC Meter Connect application. The dialog is titled 'Internet settings' and contains several sections of configuration options:

- HTTP Transfer Encoding Method:** Includes radio buttons for 'Non-Chunked (Default)' (selected) and 'Chunked'.
- Protocol:** Includes radio buttons for 'HTTPS Mode', 'FTP Mode' (selected), and 'Active'. Under 'FTP Mode', there are sub-radio buttons for 'Passive (Default)' (selected) and 'Active'.
- Proxy Address Assignment:** Includes radio buttons for 'Direct connection to the Internet (Default)' (selected), 'Use Internet Explorer proxy settings', and 'Manual proxy settings:'. Below this, there are input fields for 'Proxy Address' and 'Port' for HTTP, SSL, and FTP. A checkbox 'Use this address for all protocols' is present.
- Proxy Authentication:** Includes input fields for 'Name:' and 'Password:'.

At the bottom of the dialog are two buttons: 'OK' and 'Cancel'.

### Internet Settings Menu

1. **Firewall on “Active” FTP** - what ports should be opened on server and client side? On server port 20 for data and port 21 for commands must be opened. On the client, ports > 1023 must be opened for successful FTP connection and transfer of files.
2. **Firewall on “Passive” FTP** - what ports should be opened on server and client side? On server port 21 for commands and ports > 1023 must be opened. On the client, ports > 1023 must be opened for successful FTP connection and transfer of files.

Is there an alternate communication protocol if FTP communication is restricted on my network?

Some meters support using HTTPS as an alternative to FTP. If your meter supports this communication, use the Internet Settings menu from PC Meter Connect and select HTTPS mode. If the feature is not supported, the option is greyed out.

What type of communication does the meter use while connecting to the Pitney Bowes Data Center servers?

The meter uses HTTP on Port 80, HTTPS on Port 443, and FTP on Port 21 for communications to Pitney Bowes Data Center Servers. Port 80 is used to communicate XML formatted messages requesting services.

---

**NOTE:** For HTTPS downloads, the ports depend on the supported security for both the client and target server. If Secure Sockets Layer (SSL) is used, all communication will be on port 443. If the client and host server support Transport Layer Security (TLS), TLS is used by PC Meter Connect desktop application. If TLS is used, port 443 is used for the server, but the client will use a random higher level port.

---

Does the System use static and dynamic addressing?

PC Meter Connect uses the PC's internet connection and functions with static or dynamic IP addressing.

Is the HTTP communication “Chunked” or “Non-Chunked”?

The PC Meter Connect desktop application supports both “chunked” and “non-chunked” HTTP transfer encoding communication. By default, the PC Meter Connect uses “non-chunked”. However, Postage by Phone connectivity can be easily changed using the [Internet Settings](#) menu from PC Meter Connect. You should only make this change if necessary. Most networks will function properly with the default, Non-Chunked setting.

My network is connected to the internet via a Proxy. How do I set PC Meter Connect desktop application to use the same Proxy?

---

**NOTE:** If you have PC Meter Connect installed on your system already, when you connect your mailstation2mailstation to the PC it determines whether you have the full PC Meter Connect desktop application or only the Proxy version.

---

If your communications are routed through a proxy, you must set up the PC Meter desktop application to access the proxy. Use the [Internet Setting Menu](#) screen to set up the PC Meter Connect application to use the same either the same connection as Internet Explorer uses, or you can manually enter the proxy settings.

1. Right click on the **PC Meter Connect system tray icon**.
2. Select **Internet Settings**.
3. From the [Internet Settings Menu](#) screen in the "Proxy Address Assignment" section:
  - a. Select the **Use Internet Explorer proxy settings** option button to choose the same setting as Internet Explorer, or:
  - b. Select the **Manual proxy settings** option button. Then enter the **Name** and **Password** in the "Proxy Authentication" section.

# 12 - Adding Postage

Adding Postage to Your Machine.....	85
-------------------------------------	----

## Adding Postage to Your Machine

You can add postage to your machine any time as long as you have enough funds in your Postage By Phone® system account.

### Adding Postage Using PC Meter Connect Application

Refer to [Adding Postage using PC Meter Connect.](#)]

### Adding Postage via Internet Connection

The following method describes how to add postage if you are connecting to the PB Data Center using:

- Communication Device
  - SmartLink device
1. Press **Funds**. The amount left in the machine displays.
  2. Use the Review keys to scroll to "Refill postage?" and press **Enter/yes**. If you do not see this option, do the following:
    - a. Press **Lock** to enter sleep mode. Press **Enter/yes** to confirm.
    - b. When meter is in sleep mode, press any key to awaken it.
    - c. Enter the password for the lock code (not a password for an account) and press **Enter/Yes**.
    - d. Press **Funds** and continue at the beginning of this step (step 2).
  3. Key in the refill amount (whole numbers only). NOTE: The minimum amount of postage you can add is \$1.
  4. At the refill amount confirmation prompt, press **Enter/yes**.
  5. The machine connects to the Pitney Bowes Data Center. Various screens display showing the status of the process. When complete, the refill successful message displays.

6. Press **Enter/yes**. When prompted for a receipt, insert an envelope/tape sheet in the machine (see sample refill receipt with explanations below). When finished the main screen appears.

<b>Refill Receipt</b>	<b>Postage in Meter:</b> \$071.120	<b>Refill Amount:</b> \$050.000
	<b>Prepaid on Account:</b> \$999.000	MAY 26 09
	<b>Credit Line Available:</b> \$999.000	10:25A
		<b>Account No.:</b> 99999999
		<b>Meter No.:</b> 1100024

Description
<i>Postage in Meter:</i> Amount of postage (funds) in your meter.
<i>Prepaid on Account:</i> Amount you have left in your Postage By Phone® system account of those funds you paid for in advance (by sending in a check, direct withdrawal, etc.).
<i>Credit Line Available:</i> Amount you have left in your Postage By Phone® system account of those funds you established as credit with Pitney Bowes (such as Purchase Power®, etc.).
<i>Refill Amount:</i> Amount of your refill.
<i>Account No. :</i> Your Postage By Phone® system account number.
<i>Meter No. :</i> Your meter serial number which is printed on the meter stamp and will be on record with the USPS.

# 13 - Meter Updates and Inspections

About Meter Updates and Downloads.....	88
About Postal Rate Changes.....	89
Procedures for Downloading New Postal Rates.....	90
Performing Meter Inspections.....	91



## About Meter Updates and Downloads

When you connect to the Pitney Bowes Data Center (refer to [How You Connect to the PB Data Center](#)) to add postage or perform other transactions, the Data Center may activate other downloads while the machine is connected.

If a system update or postal update is available the system displays a message:

- If an update is not mandatory, you are prompted to either “Get Update now” or “Skip; Get later”. Select the one that makes sense to you at that time.
- If an update is mandatory, only “Get Update now” displays and you must perform the download.

A message displays when the download is complete:

- If you need to reboot the system, the prompt "Restart now" displays. Select this to restart the system.
- If it is not necessary to reboot, simply select **Continue** to return to the Home screen.

---

### IMPORTANT:

Do not remove power or the Internet connection to the Pitney Bowes Data Center during a system upgrade or rates download.

Wait until the meter has finished processing before disconnecting the meter. You will know this has occurred when the meter's Home screen showing postage and date displays

---

## Types of Downloads/Update Available

The following downloads/updates are available:

### System Update

If there has been an important update to your system, you will be notified that a required update is necessary. To initiate a system update, follow the [Procedure for Downloading New Postal Rates](#).

### Envelope Ads/Postal Inscriptions

If you ordered new envelope advertisements or postal inscriptions, you will be notified that you can perform a download to obtain these. To initiate a download for new ads or postal inscriptions, follow the [Procedure for Downloading New Postal Rates](#).

### Postal/ZIP Code Update

If the Postal Code on record at the Pitney Bowes Data Center does not match the Postal/ZIP Code of your system, the code will be downloaded into your system. (When a system is moved to a new Postal Code, the Data Center enters the new code into the record. The system is updated when a connection is made to the Data Center.) To initiate a download for Postal/ZIP Codes, follow the [Procedure for Downloading New Postal Rates](#).

### Postal Rate Update

Refer to [Downloading New Postal Rates](#) for information and details.

### Postal Inspection

Refer to [Performing Meter Inspections](#) for information and details.

## About Postal Rate Changes

Postal rates change periodically by the USPS. If new rates are available, you can download them quickly and easily directly from the Pitney Bowes Data Center. The new rates are normally available for download at least seven days before the effective date.

The display tells you when a Rate Change update is complete. It also tells you if the update is immediate or takes effect at a later date by listing the new date. Once the effective date is reached, the system automatically switches to the new rates.

Please be advised:

- If you download the update and the rates go into effect in the future, you will not print postage with the new rate until the new rates become effective.
- If the First Class rate is changing and is effective immediately, a screen displays showing the present preset postage and prompts you to reset the normal preset postage. Press **Enter**. A screen displays for you to enter the new rate.
- When a Rate Change update takes place it may also affect the preset values in your mailing machine. Check the preset settings to insure that it conforms to the new rates. Refer to [Using the Preset Feature](#) for more information.

If you need to restart an interrupted download or initiate a download for postal inscriptions, ads, system updates, or rate updates, refer to [Procedure for Downloading New Postal Rates](#).

## Downloading New Postal Rates using PC Meter Connect

If you are connected to the PB Data Center using PC Meter Connect, refer to [Downloading New Postal Rates using PC Meter Connect](#).

# Procedures for Downloading New Postal Rates

Use the procedure here to restart an interrupted download or to initiate a download for postal rate updates, inscriptions, ads, or system updates.

This procedure applies if you are connecting to the PB Data Center using:

- Internet via SmartLink - LAN Connection
- Internet via SmartLink - Wireless Connection
- Internet via Communication Device - LAN Connection
- Internet via Communication Device - Wireless Connection

If you are connected to the PB Data Center using PC Meter Connect, refer to [Downloading New Postal Rates using PC Meter Connect](#).

1. Verify that your machine is connected to the PB Data Center.
2. Press **Menu**.
3. Use the **Review** keys to scroll to "Connect to Pitney Bowes?" and press **Enter/yes**.
4. Once connected to the PB Data Center you are informed of any downloads available.
5. Follow the prompts to start the download(s) as necessary. Various screens display, letting you know the status of the process.
6. When finished, press **Enter/yes** to return to the main screen.

7. Print a last rates update report when prompted. See the figure below.

Last Rates Update	<b>System will begin using new rates on the date effective.</b>			<b>Meter No.:</b> 3231234
	<b>Description</b>	<b>Version</b>	<b>Effective</b>	<b>Page 1 of 1</b>
	Code / Zone	C .01	06 08 28	
	CPC Rates	F .02	06 08 28	
	<b>Downloaded:</b>	06 08 27 11:59A	<b>Printed:</b> 06 08 27 12:05P	

**Description**

*Description:* The specific type of rate that is affected.

*Version:* The alpha-numeric identifier used for this rate.

*Effective Date:* The date the new rates take effect.

*Meter No. :* Your meter serial number which is printed on the meter stamp and on record with the USPS.

*Downloaded :* The date and time the new rates were downloaded into the machine.

*Printed:* The date and time this report was printed.

## Performing Meter Inspections

The USPS requires a postal inspection of your machine every 120 days.

This postal inspection requirement can be automatically met by connecting to the Pitney Bowes Data Center to check your Postage By Phone® meter payment account balance or to add postage to your meter.

Please be Advised:

When your machine's display prompts:

**Inspection Due:** You will have 30 days to print postage but it is recommended that you connect to the PB Date Center at this time to allow the inspection.

**Inspection Required:** you will not be able to use your mailing machine until your system is inspected. Connect to the Pitney Bowes Data Center to satisfy the postal inspection requirement.

- Connect to the PB Data Center. Refer to [How You Connect to the PB Data Center](#) for more information on possible ways of connecting to the Data Center.
- Follow the prompts on the "Inspection Due" screen, or,

- Press the **Funds** key on the control panel and select "Check amt available to download?" (this will not decrease or change the funds in your account).

If you are connected to the PB Data Center using PC Meter Connect, refer to [Performing Meter Inspections Using PC Meter Connect](#).

# 14 - Maintenance

Ink Cartridge Replacement Messages.....	94
Replacing the ink cartridge.....	94
Printing a Test Pattern.....	98
Cleaning printer nozzles.....	99
Cleaning or Replacing the Print Head.....	101
Replacing the Ink Tray.....	105

# Ink Cartridge Replacement Messages

---

**NOTE:** Please be sure to keep a spare ink cartridge on hand at all times.

---

Your actual ink usage will vary, depending on whether you routinely print ads, the number of pieces of mail you print a day and other factors. The following messages regarding ink supply status appear on the machine display:

## “Low Ink”

Replace the ink cartridge soon. You can print about another 300 impressions or leave the system running for six days without printing. If you don't have a replacement cartridge on hand, you should order one now. Refer to the Contact List for information on ordering supplies.

## “Ink Out”

Replace the ink cartridge immediately. The ink supply is gone you will not be able to print any postage.

## Replacing the ink cartridge

Try replacing your ink cartridge to improve your print quality on the mailstation and mailstation2.

### Step 1: Watch the video

### Step 2: Replace the ink cartridge

- a. Press **Menu**.
- b. Press **Review (down)** until the message **Use ink functions?** displays and press **Enter/yes**.
- c. Press **Review (down)** until the message **Replace ink cartridge?** displays and press **Enter/yes**

- d. Lift the control panel and locate the ink cartridge (see ink cartridge in white circle on image).

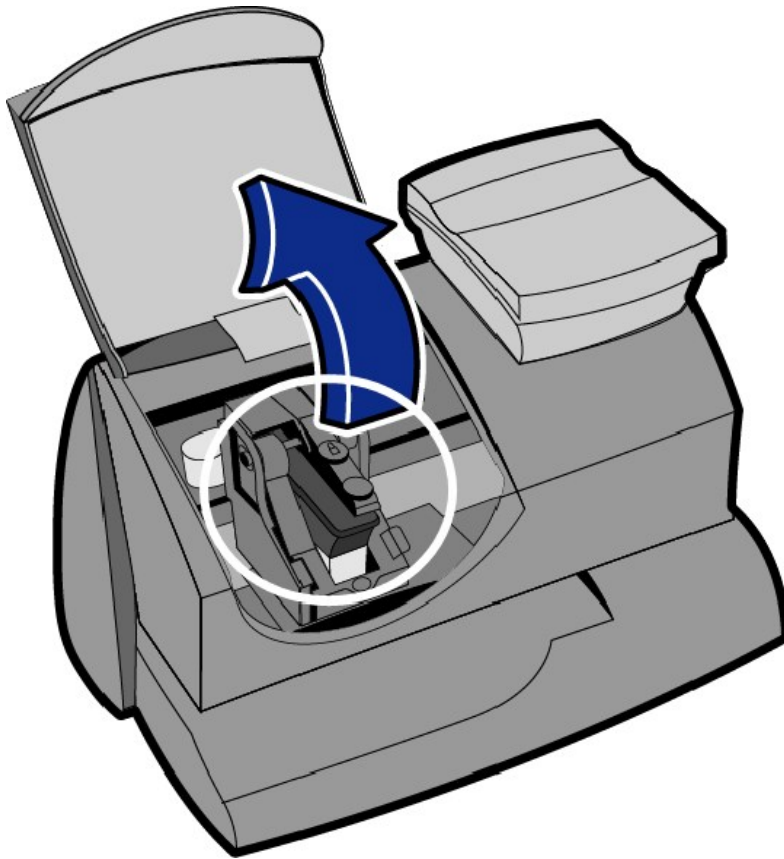

- e. Press the unlock icon to open the ink cartridge latch as shown in the image.

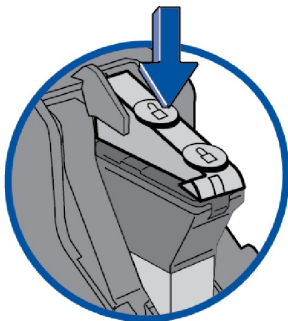

- f. Tilt the old ink cartridge toward you and lift it out. Discard the old cartridge.



- g. Remove the new cartridge from its packaging and pull off the protective tape covering the vent and ink holes as shown below.

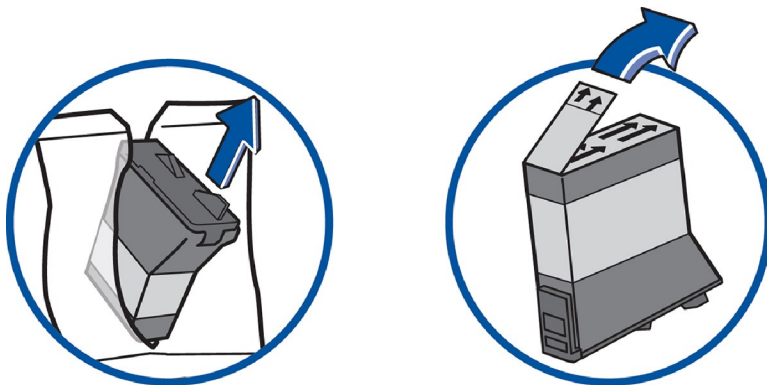

- h. Insert the new ink cartridge by tilting it towards you and then insert it into print head. Straighten the cartridge into an upright position.

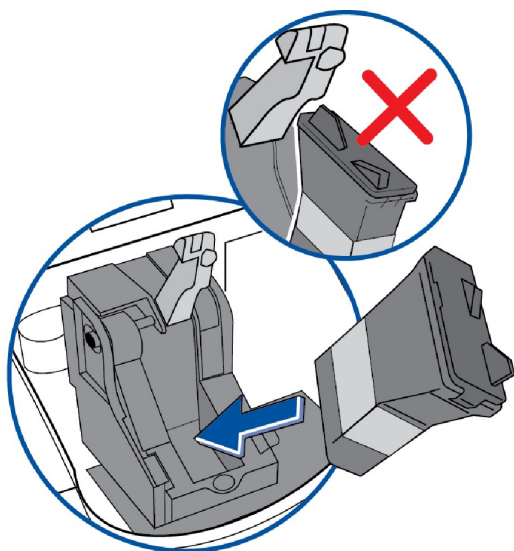

- i. Press down on the ink cartridge latch until it locks into place.

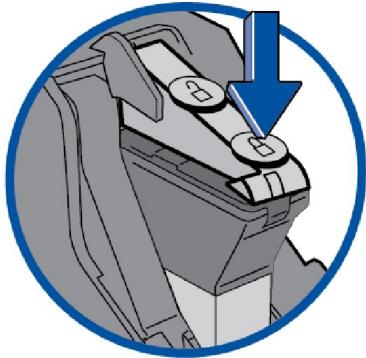

- j. Close the machine cover. Press **Enter/yes**.



- k. Press **Enter/yes** to confirm the replacement. Wait while the system performs an initialization.

- I. When prompted, insert an envelope or tape sheet to print a test pattern.
- The test pattern should look like the sample below (no missing lines). If it does, then press **Enter/yes**.

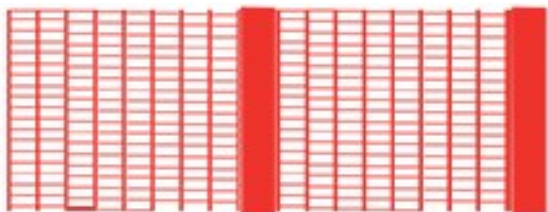

Good Test Print

- If the test pattern looks like the sample below (missing lines), then press **No** and refer to [Cleaning the Printer Nozzles](#).

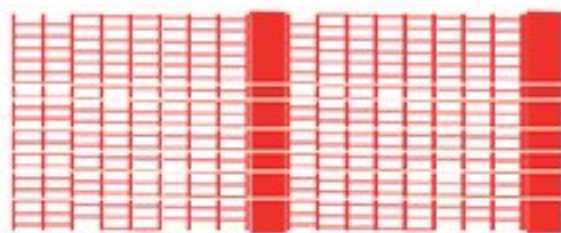

Poor Test Print

#### Related articles

- ["Low ink" or "Ink out" message on the mailstation and mailstation2](#)
- [Poor print quality or no printing on the mailstation and mailstation2](#)
- If you need ink, order a genuine Pitney Bowes replacement ink cartridge:



mailstation2



mailstation

## Printing a Test Pattern

Printing a test pattern lets you see if the printhead is functioning properly or if you have enough ink in the cartridge.

1. Press **Menu**.
2. Use the **Review** keys to scroll to "Use ink functions?" and press **Enter/yes**.
3. Use the **Review** keys to scroll to "Print test pattern?" and press **Enter/yes**.
4. When prompted, insert an envelope or tape sheet into the machine. After a few seconds, remove envelope when prompted.
  - The test pattern should look like the sample below (no missing lines). If it does then press **Enter/yes**.

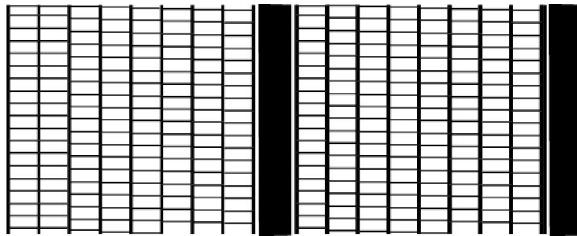

**Good Test Print**

- If the test pattern looks like the sample below (missing lines), press **No**, and refer to [Cleaning the Printer Nozzles](#).

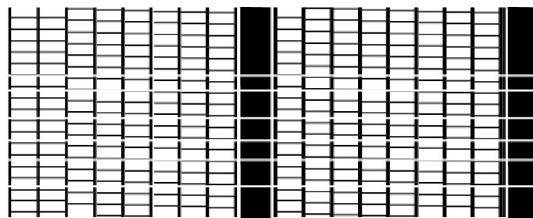

**Poor Test Print**

## Cleaning printer nozzles

If you get a bad test print pattern, clean your print nozzles to try and correct the problem.

1. Press **Menu**.
2. Press **Review (down)** until **ink functions?** displays.

3. Press **Enter/Yes**.
4. Press **Review (down)** until **Clean Printer Nozzles?** displays.
5. Press **Enter/Yes**. The message **Preparing ink please wait...** displays while your meter performs the cleaning.
6. When prompted, insert an envelope or tape sheet into your machine.
7. When prompted, remove the envelope.
8. At the prompt **Is test pattern OK**, select the appropriate option:
  - If your test pattern is good, without broken lines or smeared ink, press **Enter/Yes**. Your meter returns to the main screen.

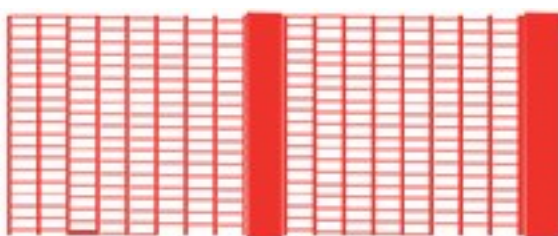

- If your test pattern is poor, press **No** to run the **Clean Printer Nozzles?** maintenance function again.

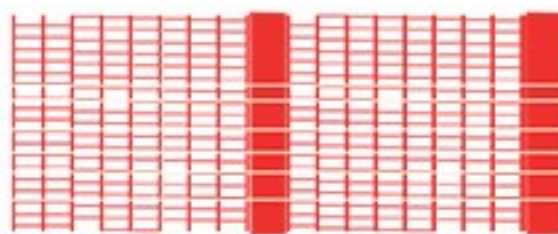

- a. Press **Clear/Back**.
- b. Return to Step 2 and repeat the **Clean Printer Nozzles?** function up to 3 times, if needed, to improve poor print quality.

### Related topic

- [Mauvaise qualité d'impression ou aucune impression sur la série mailstation](#)
- [Poor print quality or no printing on the mailstation series](#)
- [Poor print quality or no printing on the mailstation series](#)

## Cleaning or Replacing the Print Head

---

**IMPORTANT:** This procedure should only be done under the direction or with the permission of a Pitney Bowes representative. This procedure can also be used to reseal the print head in response to a possible error condition.

---

If you are still experiencing poor print quality after *cleaning the printer nozzles*, you can try cleaning the print head. If that does not fix the problem, replace the print head.

1. Press **Menu**.
2. Use the **Review** keys to scroll to "Use ink functions?" and press **Enter/yes**.
3. Use the **Review** keys to scroll to "Install new print head?" and press **Enter/yes**.
4. Lift the control panel and locate the print head.
5. Press the unlock symbol to open the cartridge holder as shown in the image below .



6. Tilt the ink cartridge toward you and lift out. The cartridge may leak from the bottom. Place it on a napkin.

7. Squeeze the latches holding the print head guard in place.

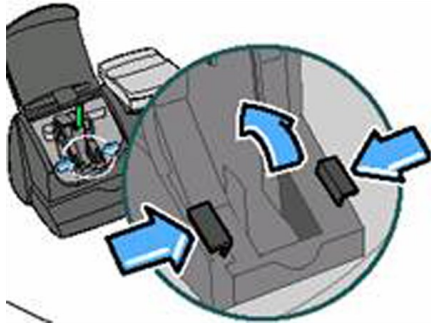

8. Lift up the print head guard to expose the print head.
9. Squeeze the latches holding your print head in place and lift your print head out of the machine.

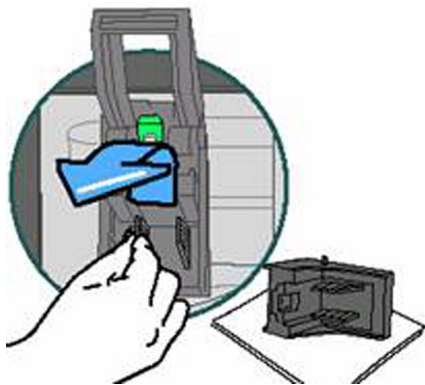

10. Clean, reseal, or replace the print head:

- a. If you are reseating the print head, proceed to step 11.
- b. If you are cleaning the print head use a soft, lint-free cloth to wipe off the bottom of the print head as shown here. Proceed to step 11.

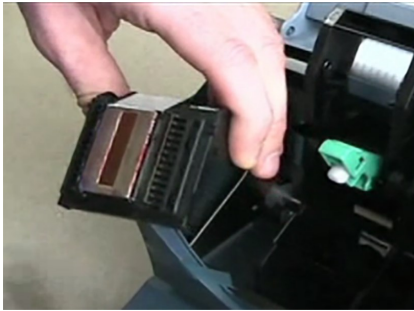

- c. If you are replacing the print head, remove the new print head's protective parts by squeezing the yellow tabs on the white print head holder. Keep this part to re-package your old print head for return to Pitney Bowes.





11. Place the new or cleaned print head back in the machine by angling it back and down until it clicks back into place.

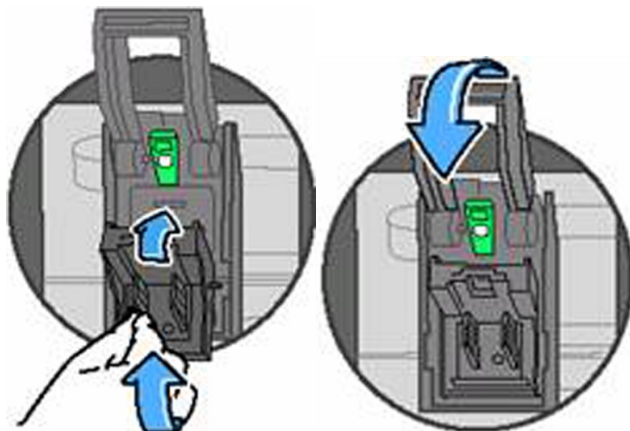

12. Replace the existing ink cartridge or install the new one that comes with the new print head.

13. Push down on ink cartridge latch until it locks in place.



14. Close the control panel and press **Enter/yes**.
15. The message "IMPORTANT - is print head/ink installed?" appears in the display.
16. Press **Enter/yes** to confirm the replacement. The system performs a print head initialization. This takes about 2-3 minutes.
17. When prompted, insert an envelope/tape sheet to *print a test pattern* to confirm print quality.
18. If test pattern looks good, press **Enter/yes**.
19. If you replaced the print head, place the old print head in the yellow and white protection parts and return to Pitney Bowes.

## Replacing the Ink Tray

The ink waste tank is nearly full message appears when the waste tray (also called a waste tank) has neared capacity. **Once your waste tray is actually full, your meter will have to be replaced.** This can be avoided by replacing your waste tray as soon as the warning message appears.

---

**IMPORTANT:** This procedure should only be done under the direction or with the permission of a Pitney Bowes representative.

---

Before you start:

To order a new waste tray, call the supply line at 1.800.243.7824 and request:

Procedure:

1. Locate the button on the bottom right corner on the back of your machine.

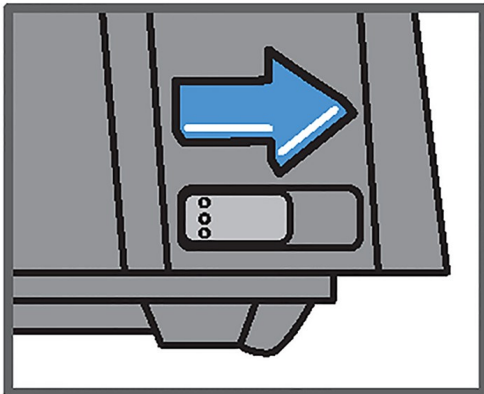

2. Slide the button to the right and hold.

3. Pull the ink tray out from the rear of the machine and release the button.



4. Check to see if the tray is fully saturated with ink. If it looks like it is not yet near capacity, you may be able to continue using the meter without a replacement tray for a little while longer. If it is near capacity remove the tray and place it on a napkin.
5. Remove the new ink tray from the envelope.
6. Insert the new tray into the rear of the machine until it clicks in place.
7. Put the old ink tray in the envelope.
8. Press **Menu**.
9. Use the **Review** keys to scroll to "Use ink functions?" and press **Enter/yes**.
10. Use the **Review** keys to scroll to "Replace ink tray?" and press **Enter/yes**.
11. Enter the four-digit code. The code is **..57** (period period 57).
12. Press **Enter/yes**.